

loyratime.com

muebles
GRUPO **INTERMOBEL**

Loyra es una empresa valenciana fundada en 1996 como evolución de una empresa familiar arraigada a la tradición de mobiliario para el hogar. En sus instalaciones se combinan técnicas artesanales con la más avanzada tecnología junto a un equipo humano altamente cualificado para lograr el máximo nivel de atención y calidad del producto.

Nuestros diseños buscan ofrecer no sólo un producto en sí, sino un concepto de amueblamiento integral que ayude al consumidor a encontrarse con una atmósfera que satisfaga sus necesidades tanto estéticas como funcionales.

La colaboración del diseñador valenciano Ximo Roca con la empresa se remonta al año 2013, una relación que se mantiene viva produciendo diseños y conceptos sensoriales que dotan de una personalidad única a la colección.

Viajamos a través de la vanguardia con el valioso equipaje de nuestra experiencia, tecnología, equipo humano y vocación por el trabajo bien hecho. El resultado es nuestra interpretación de la exclusividad y la elegancia en un hábitat funcional de líneas innovadoras totalmente personalizables.

Nuestros productos son íntegramente fabricados en España, garantizando desde la selección de las mejores materias primas, instalación de los herrajes de mayor prestigio hasta los acabados de alta gama.

Loyra is a valencian company founded in 1996 as the evolution of a family business rooted in the tradition of home furniture. Its facilities combine handcrafted techniques with the most advanced technology together with a highly qualified human team to achieve the highest level of attention and product quality.

Our designs seek to offer not only a product in itself, but a concept of comprehensive furnishing that helps the consumer to find an atmosphere that meets their needs both aesthetic and functional.

The collaboration of Valencian designer Ximo Roca with the company dates back to 2013, a relationship that is kept alive by producing designs and sensory concepts that give a unique personality to the collection.

We travel through the avant-garde with the valuable baggage of our experience, technology, human team and vocation for a well done job. The result is our interpretation of exclusivity and elegance in a functional habitat of totally customizable innovative lines.

Our products are entirely manufactured in Spain, ensuring from the selection of the best raw materials, installation of the most prestigious hardware to high-end finishes.

muebles
GRUPO **INTERMOBIL**

MADE
SPAIN



muebles
GRUPO **INTERMOBEL**

*Original es aquello
que vuelve a la
simplicidad de las
primeras soluciones.*

Original is that which returns to the simplicity of the first solutions.

Antonio Gaudí

muebles
GRUP **INTERMOBEL**



meubles
INTERMOBEL



- ▲ IOS sistema modular, estructura en arena mate, puertas y cajones en roble ceniza, puerta cristal transparente metal negro, con iluminación led / MOSS programa
 ▲ contenedores, estructura exterior, puertas y cajones en roble ceniza, estructura interior en arena mate, puerta cristal dark grey metal negro, patas en metal negro /
 ▲ KONE mesa, tapa en roble ceniza, estructura en metal negro / NUDOS mesa baja, tapa en roble ceniza, estructura en metal negro / TEMPLE sofá, tapizado en tela, pata
 en metal negro / POPPEA silla, asiento en negro, base tapizada en tela, estructura en metal negro / POPPEA butaca, asiento tapizado en tela, estructura en metal negro.
 IOS modular system, matt arena structure, roble ceniza doors and drawers, transparent glass door and black metal, with led lighting / MOSS container program,
 roble ceniza outer structure, doors and drawers, matt arena inner structure, dark grey glass door and black metal, black metal legs / KONE table, roble ceniza
 top cover, black metal structure / NUDOS low table, roble ceniza top cover, black metal structure / TEMPLE sofa, upholstered in fabric, black metal structure /
 POPPEA chair, negro seat shell, upholstered fabric base, black metal structure / POPPEA armchair, fabric upholstered seat shell, black metal structure.

muebles
INTERMOBEL



IOS sistema modular, estructura en arena mate, puertas y cajones en roble ceniza, puerta cristal transparente metal negro, con iluminación led / KONE mesa comedor, tapa en roble ceniza, estructura en metal negro / POPPEA silla, asiento en negro, base tapizada en tela, estructura en metal negro.
IOS modular system, matt arena structure, roble ceniza doors and drawers, transparent glass door and black metal, with led lighting / KONE table, roble ceniza top cover, black metal structure / POPPEA chair, negro seat shell, upholstered fabric base, black metal structure.

MODULO
INTERMOBEL

LOYRATIME

DAY COLLECTION



- ▲ **MOSS** programa contenedores, estructura exterior puertas y cajones en roble ceniza, estructura interior en arena mate, puerta cristal dark grey metal negro, patas en metal negro / **NUDOS** mesa baja, tapa en roble ceniza, estructura en metal negro
 MOSS container program, roble ceniza outer structure, doors and drawers, matt arena inner structure, dark grey glass door and black metal, black metal legs / **KONE** table, roble ceniza top cover, black metal structure / **NUDOS** low table, roble ceniza top cover, black metal structure
- ▶ **TINO** butaca, tapizado en tela, estructura balancín en metal negro y roble claro.
 TINO, armchair, upholstered in fabric, black metal and roble claro swing structure.



GRUPO **muebles**
INTERMOBEL



muebles
GRUPPO **INTERMOBEL**



▲ Q3 contenedores a pared, estructura en nogal nut, frentes en blanco mate / LENE mesas bajas, tapa en blanco mate, estructura en nogal nut / WRAP sofá, tapizado en tela.

Q3 wall containers, nogal nut structure, matt blanco fronts / LENE low table, matt blanco top cover, nogal nut structure / WRAP sofa, upholstered in fabric.

◀ YOKO sistema modular, módulos en grafito mate, divisores en grafito mate, tórtola mate, blanco mate, gris mate, contenedores cerrados y contenedor tv en nogal nut, contenedores abiertos en antracita mate, contenedor cristal transparente / AMARA mesa, tapa en porcelánico duomo, estructura en nogal nut / MARIQUITA silla, funda tapizada en tela, estructura en metal negro / LENE mesa baja, tapa en blanco mate, estructura en nogal nut / WRAP sofá, tapizado en tela / TINO butaca, tapizado en tela, estructura en metal negro.

YOKO modular system, matt grafito module, matt tórtola, matt blanco and matt gris dividers, nogal nut closed containers and tv. container, matt antracita open containers, transparent glass showcase / AMARA table, porcelain duomo top cover, nogal nut structure / MARIQUITA chair, upholstered fabric cover, black metal structure / LENE low table, matt blanco top cover, nogal nut structure / WRAP sofa, upholstered in fabric / TINO armchair, upholstered in fabric, black metal structure.

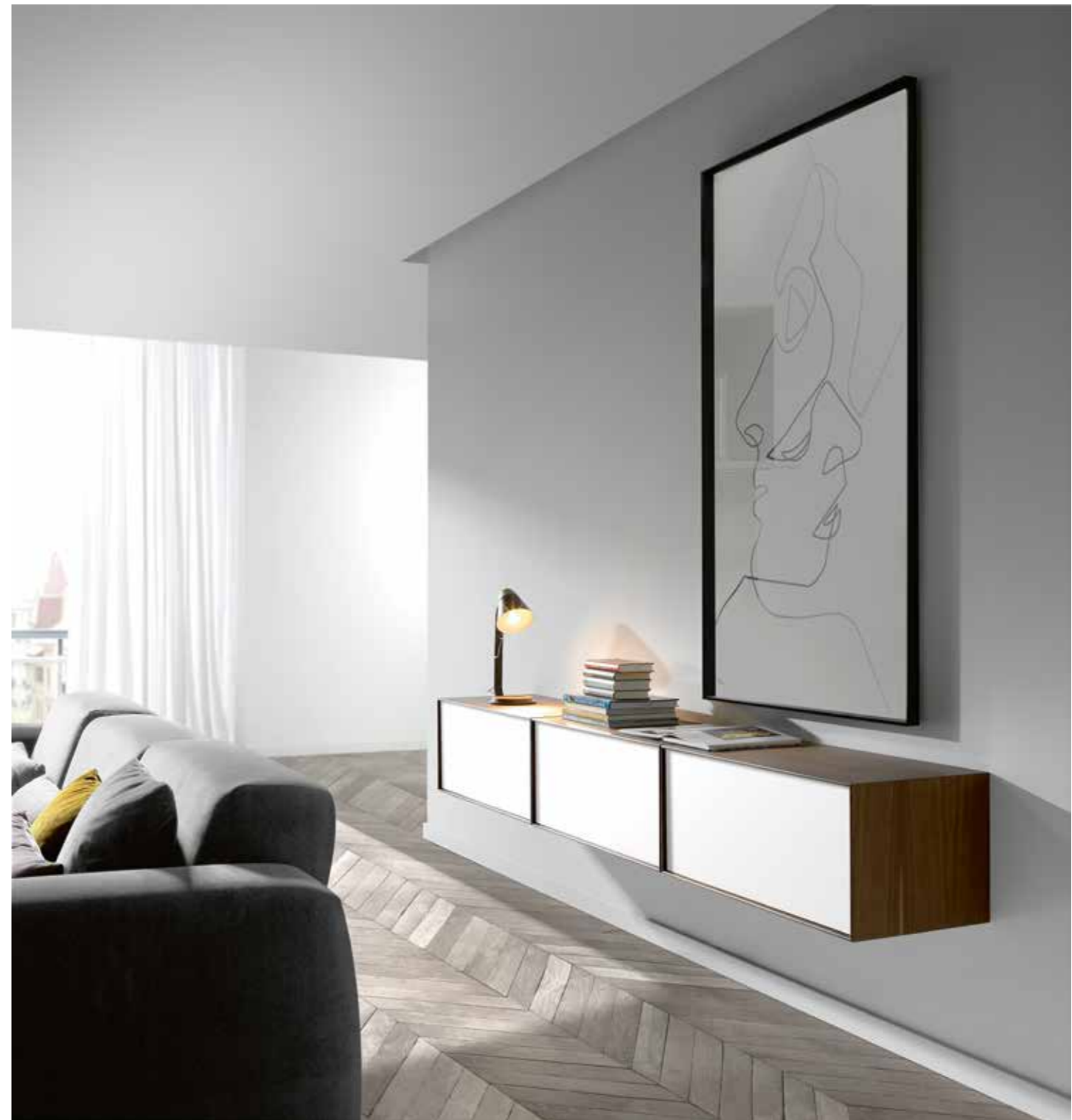

muebles
GRUPO **INTERMOBEL**

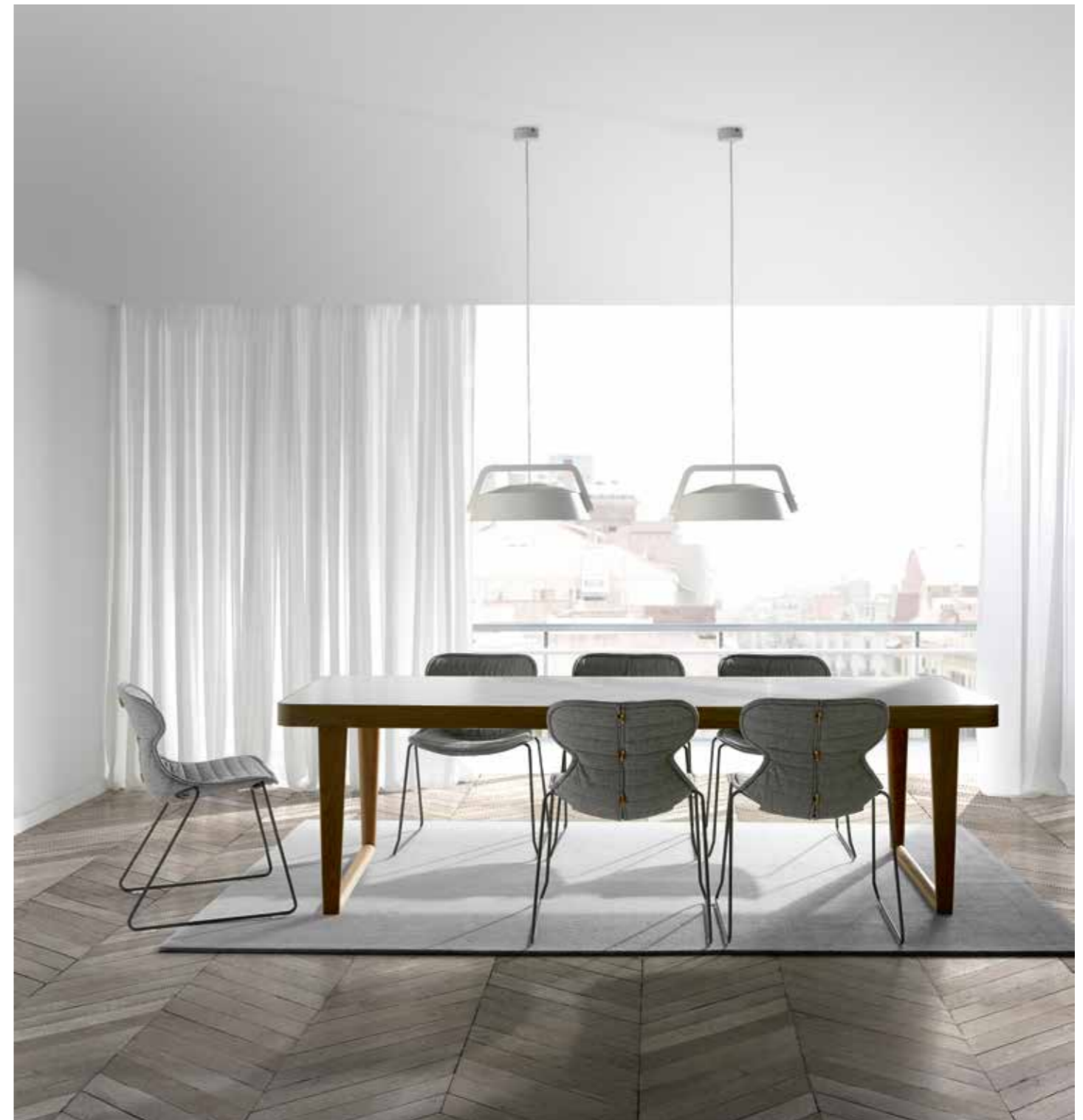

AMARA mesa, tapa en porcelánico duomo, estructura en nogal nut /
MARIQUITA silla, funda tapizada en tela, estructura en metal negro.
AMARA table, porcelain duomo top cover, nogal nut structure /
MARIQUITA chair, upholstered fabric cover, black metal structure.

INTERMOBEL

LOYRATIME

DAY COLLECTION



YOKO sistema modular, módulos en grafito mate, divisores en grafito mate, tórtola mate, blanco mate y gris mate, contenedores cerrados y contenedor tv en nogal nut, contenedores abiertos en antracita mate, contenedor cristal transparente.
 YOKO modular system, matt grafito module, matt tórtola, matt blanco and matt gris dividers, nogal nut closed containers and tv. container, matt antracita open containers, transparent glass showcase.



muebles
 GRUPO **INTERMOBEL**



muebles
INTERMOBEL



- ▲ Q contenedores a pared, estructura y frentes en polvo mate, tinta mate / LENE mesa baja, tapas en polvo alto brillo y tinta alto brillo, estructuras en roble humo / POPPEA butaca, asiento tapizado en tela, estructura en metal negro / TEMPLE sofá, tapizado en tela, estructura en metal negro.
 Q wall container, matt polvo and matt tinta structures and fronts / LENE low table, high gloss polvo and high gloss tinta top covers, roble humo structures / POPPEA armchair, fabric upholstered seat shell, black metal structure / TEMPLE sofa, upholstered in fabric, black metal structure.
- ◀ MOSS programa contenedores, estructura exterior y frentes de madera en roble humo, estructura interior en gris mate, frentes cristal transparente metal negro, con iluminación led / AMARA mesa, tapa en porcelánico paladio, estructura en roble humo / POPPEA silla, asiento en polvo, base tapizada en tela, estructura en metal negro.
 MOSS container program, roble humo outer structure and drawers, matt gris inner structure, transparent glass door and black metal, with led lighting / AMARA table, porcelain paladio top cover, roble humo structure / POPPEA chair, polvo seat shell, upholstered fabric base, black metal structure.

muebles
INTERMOBEL



▲ BRICH mesa baja, estructura en roble ceniza, tapa en porcelánico paladio, patas en metal negro.

BRICH low table, roble ceniza structure, porcelain paladio top cover, black metal legs.

► POPPEA butaca, asiento tapizado en tela, estructura en metal negro.

POPPEA armchair, fabric upholstered seat shell, black metal structure.



muebles
GRUPO **INTERMOBEL**

*The details are not
the details. They
make the design.*

Los detalles no son los detalles. Los detalles son el diseño.

Charles Eames

muebles
GRUPO **INTERMOBEL**



GRUPPO
muebles
INTERMOBEL



muebles
INTERMOBEL



▲ IOS sistema modular, estructura y guía corredera en tórtola mate, panel tv. y cajones en roble ceniza, cajonera tv. en antracita mate, puerta corredera en cristal / dark grey / YOKO sistema modular, módulo y divisores en arena mate, contenedor cerrado en roble ceniza, contenedor cristal transparente / BRICH mesa baja, estructura en roble ceniza, tapa en antracita mate, patas en metal negro / WRAP sofá, tapizado en tela / TINO butaca, tapizado en tela, patas en metal negro.
 IOS modular system, matt tórtola structure and sliding guide, roble ceniza tv. panel and drawers, matt antracita tv. drawer, dark grey glass sliding door / YOKO modular system, matt arena module and dividers, roble ceniza closed container, transparent glass showcase / BRICH low table, roble ceniza structure, matt antracita top cover, black metal legs / WRAP sofa, upholstered in fabric / TINO armchair, upholstered in fabric, black metal legs.



- ▲ BRICH mesa baja, estructura en roble ceniza, tapa en antracita mate, patas en metal negro / WRAP sofá, tapizado en tela / AMARA mesa, tapa en porcelánico duomo, estructura en roble ceniza / OLE silla, tapizada en tela, estructura en metal negro.
 BRICH low table, roble ceniza structure, matt antracita top cover, black metal legs / WRAP sofa, upholstered in fabric / AMARA table, porcelain duomo top cover, roble ceniza structure / OLE chair, upholstered fabric seat shell, black metal structure.
- WRAP sofá, tapizado en tela.
 WRAP sofa, upholstered in fabric.



muebles
GRUPO INTERMOBEL



AMARA mesa, tapa en porcelánico duomo, estructura en roble ceniza / OLE silla, tapizada en tela, estructura en metal negro.
 AMARA table, porcelain duomo top cover, roble ceniza structure /
 OLE chair, upholstered fabric seat shell, black metal structure.



MOSS programa contenedores, estructura exterior, puertas y cajones en roble ceniza, estructura interior en arena mate, puerta cristal dark grey metal negro, patas en metal negro.
 MOSS container program, roble ceniza outer structure, doors and drawers, matt arena inner structure, dark grey glass door and black metal, black metal legs.

muebles
 GRUPO **INTERMOBEL**



muebles
INTERMOBEL



- ◀ Q contenedores a pared, estructura y frentes en roble humo, cactus mate, puerta cristal transparente metal negro / BRICH mesa baja, estructura en roble humo, tapa en cactus mate, patas en metal negro / RHO mesa, tapa y estructura en roble humo / MARIQUITA silla, asiento en cactus, estructura en cactus mate.
Q wall container, roble humo and matt cactus structure and fronts, transparent glass door and black metal / BRICH low table, roble humo structure, matt cactus top cover, black metal legs / RHO table, top cover and structure in roble humo / MARIQUITA chair, cactus seat shell, matt cactus structure.

- ▶ WRAP sofá, tapizado en tela.
WRAP sofa, upholstered in fabric.

GRUPO **muebles**
INTERMOBEL





muebles
GRUPO **INTERMOBEL**



- ◀ IOS sistema modular, estructura en arena mate, puerta cristal transparente metal negro, con iluminación led / IOS sistema modular, estructura, cajones y tapa en roble humo / AMARA mesa, tapa en porcelánico paladio, estructura en roble humo / OLE silla, tapizada en piel sintética, estructura giratoria en metal negro / BRICH mesa baja, estructura en roble humo, tapa en porcelánico paladio, patas en metal negro / TEMPLE sofá, tapizado en tela, estructura en metal negro.
 IOS modular system, matt arena structure, transparent glass door and black metal, with led lighting / IOS modular system, roble humo structure, drawers and top cover / AMARA table, porcelain paladio top cover, roble humo structure / OLE chair, upholstered in synthetic leather, black metal revolving base / TEMPLE sofa, upholstered in fabric, black metal structure / BRICH low table, roble humo structure, porcelain paladio top cover, black metal legs.
- ▶ TEMPLE sofá, tapizado en tela, estructura en metal negro.
 TEMPLE sofa, upholstered in fabric, black metal structure.



muebles
GRUPO INTERMOBEL



*Everything is design,
and the quality of
design affects the
quality of our lives.*

Todo es diseño, y la calidad del diseño afecta la calidad de nuestras vidas.

Norman Foster

GRUPO **muebles**
INTERMOBEL



muebles
INTERMOBEL



INTERMOBEL



- ◀ IOS sistema modular, estructura en arena mate, puerta cristal transparente metal negro, con iluminación led / KONE mesa, tapa en nogal nut, estructura en metal negro / OLE silla, asiento en antracita, base tapizada en tela, estructura en nogal nut.
 IOS modular system, matt arena structure, transparent glass door and black metal, with led lighting / KONE table, nogal nut top cover, black metal structure / OLE chair, antracita seat shell, upholstered fabric base, nogal nut structure.
- ▶ KONE mesa, tapa en antracita mate, estructura en metal negro.
 KONE table, matt antracita top cover, black metal structure.



muebles
 GRUPO **INTERMOBEL**



YOKO sistema modular, módulos y divisores en blanco mate, contenedores cerrados y tapa escritorio en roble claro, contenedor cristal dark grey / OLE silla, asiento en roble claro, base tapizada en tela, estructura giratoria en metal negro / DALEN mesa baja, tapizada en tela, bandeja en metacrilato transparente / POPPEA butaca, asiento tapizado en tela, estructura en metal negro / WRAP sofá, tapizado en tela.
 YOKO modular system, matt blanco modules and dividers, roble claro closed containers and desk shelf, dark grey glass showcase / OLE chair, roble claro seat shell, upholstered fabric base, black metal revolving base / DALEN low table, upholstered in fabric, transparent methacrylate tray / POPPEA armchair, fabric upholstered seat shell, black metal structure / WRAP sofa, upholstered in fabric.

muebles
GRUPO INTERMOBEL



YOKO sistema modular, módulos y divisores en blanco mate, contenedores cerrados y tapa escritorio en roble claro, contenedor cristal dark grey / OLE silla, asiento en roble claro, base tapizada en tela, estructura giratoria en metal negro / DALEN mesa baja, tapizada en tela, bandeja en metacrilato transparente.
 YOKO modular system, matt blanco modules and dividers, roble claro closed containers and desk shelf, dark grey glass showcase / OLE chair, roble claro seat shell, upholstered fabric base, black metal revolving base / DALEN low table, upholstered in fabric, transparent methacrylate tray.

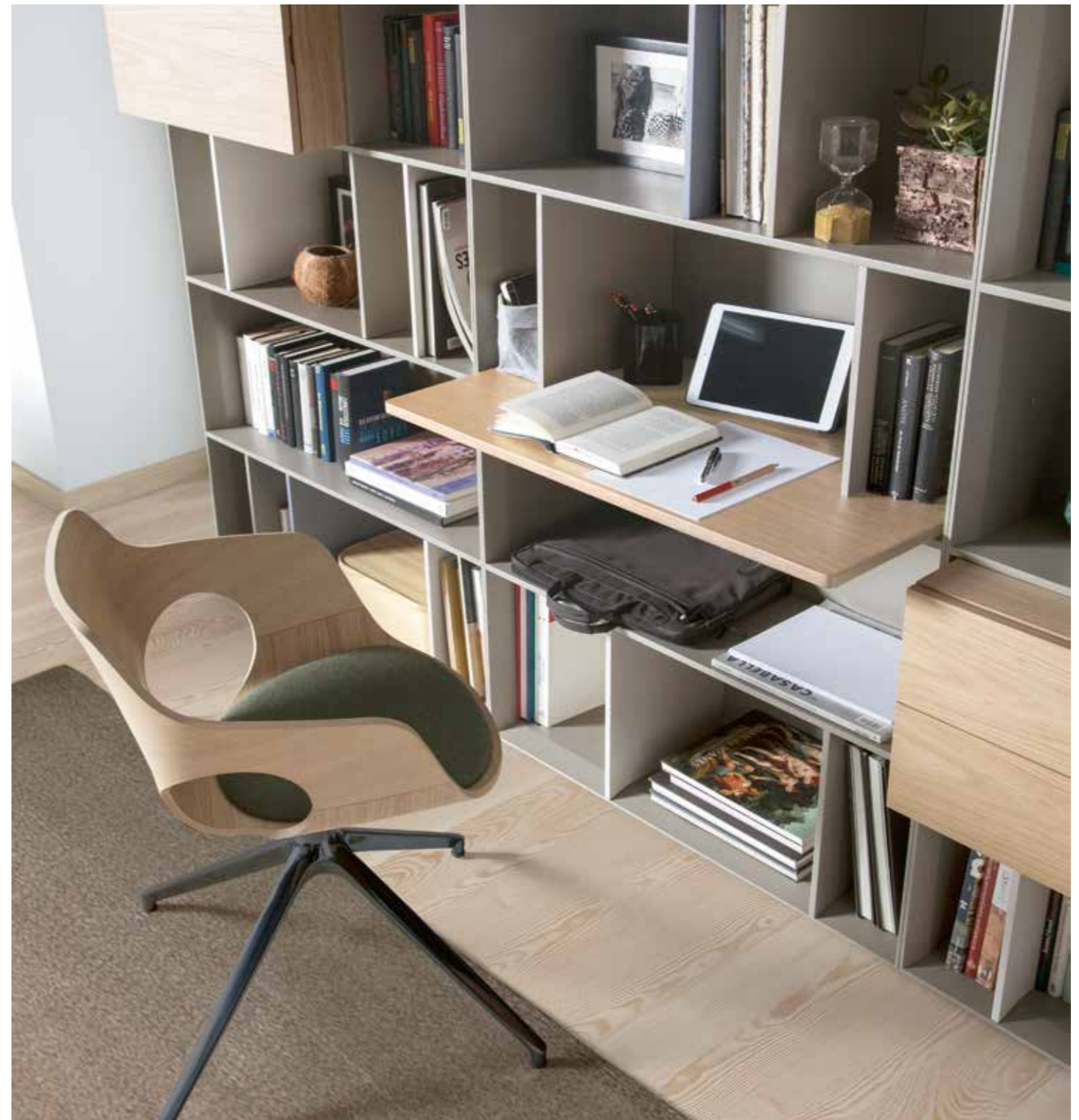

muebles
 GRUPO **INTERMOBEL**



GRUPPO
INTERMOBEL



▲ IOS sistema modular, estructura y cajones en roble humo, panel tv., panel escritorio y estante escritorio en grafito mate, cajonera tv en antracita mate, frentes cristal transparente
 ◀ metal negro, con iluminación led / MOSS programa de contenedores, estructura exterior y puertas en eucalipto ahumado, estructura interior en antracita mate, patas en metal negro / LENE mesa baja, tapa en nogal nut, estructura en antracita mate / DALEN mesa baja, tapa y estructura en blanco mate / OLE silla, asiento en antracita, estructura giratoria en metal negro / TEMPLE sofá, tapizado en tela, estructura en metal negro / TINO butaca, tapizado en tela, estructura balancín en metal negro y roble claro.
 IOS modular system, roble humo structure and drawers, matt grafito tv. panel, desktop panel and desk shelf, matt antracita tv drawer, transparent glass door and black metal, with led lighting / MOSS container program, eucalipto ahumado outer structure and doors, matt antracita inner structure, black metal legs / LENE low table, nogal nut top cover, matt antracita structure / DALEN low table, matt blanco top cover and structure / OLE chair, antracita seat shell, black metal revolving base / TEMPLE sofa, upholstered in fabric, black metal structure / TINO armchair, upholstered in fabric, black metal and roble claro swing structure.



muebles
GRUPO INTERMOBEL

LOYRATIME

DAY COLLECTION



Q contenedores a pared, estructura y frentes en nogal nut, tórtola mate / VESTA mesa, tapa en nogal nut, estructura en metal negro / OLE silla, asiento tapizado en tela, estructura giratoria en metal negro / POPPEA butaca, asiento tapizado en tela, estructura en metal negro.
 Q wall container, nogal nut and matt tórtola structure and front / VESTA table, nogal nut top cover, black metal structure / OLE chair, upholstered fabric seat shell, black metal revolving base / POPPEA armchair, fabric upholstered seat shell, black metal structure.

m u e b l e s
GRUPO INTERMOBEL



- ◀ Q contenedores a pared, estructura y frentes en nogal nut, tórtola mate /
OLE silla, asiento tapizado en tela, estructura giratoria en metal negro.
*Q wall container, nogal nut and matt tórtola structure and fronts / OLE
chair, upholstered fabric seat shell, black metal revolving base.*
- ▶ OLE silla, asiento tapizado en tela, estructura madera.
OLE chair, upholstered fabric seat shell, wooden structure.



GRUPO **muebles**
INTERMOBEL



muebles
GRUPPO
INTERMOBEL



- ◀ IOS sistema modular, estructura y guía corredera en nogal nut, puerta corredera en arena mate, cubo multimedia y apoyos U en tórtola mate / DALEN mesa baja, tapa en nogal nut y tórtola mate, estructura en metal negro / WRAP sofá, tapizado en tela.
 IOS modular system, nogal nut structure and sliding guide, matt arena sliding door, matt tórtola multimedia cube and free inner divider U / DALEN low table, nogal nut and matt tórtola top cover, black metal structure / WRAP sofa, upholstered in fabric.
- ▲ VESTA mesa, tapa en arena mate, estructura en metal negro / ROA silla, asiento tapizado en tela, estructura en nogal nut.
 VESTA table, matt arena top cover, black metal structure / ROA chair, fabric upholstered seat, nogal nut structure.

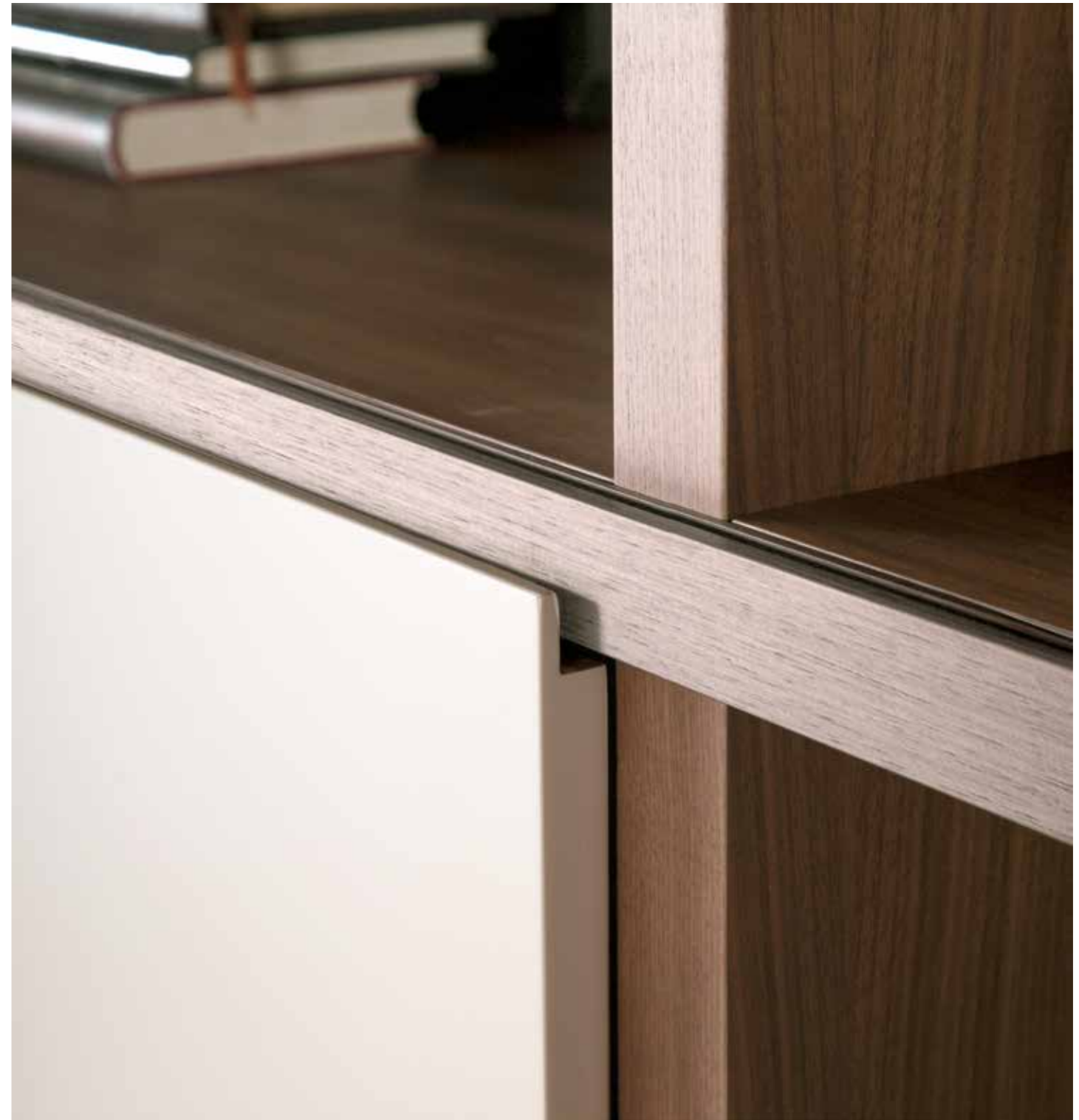

muebles
GRUPO INTERMOBEL



meubles
GRUPPO
INTERMOBEL



- ◀ YOKO sistema modular, módulos y divisores en gris mate, contenedores cerrados en roble claro, contenedor cristal dark grey, patas en metal negro / Q3 contenedores a pared, estructura en roble claro, frentes en blanco mate / NUDOS mesa baja, tapa en gris mate, estructura en metal negro.
 YOKO modular system, matt gris modules and dividers, roble claro closed containers, dark grey glass showcase, black metal legs / Q3 wall container, roble claro structure, matt blanco fronts / NUDOS low table, matt gris top cover, black metal structure.
- ▶ YOKO sistema modular, módulos y divisores en gris mate, contenedores cerrados en roble claro, contenedor cristal transparente.
 YOKO modular system, matt gris modules and dividers, roble claro closed containers, transparent glass showcase.

muebles
 GRUPO **INTERMOBEL**



*It is very difficult to
have ideas; when
they arrive they have
to fight for them.*

Es muy difícil tener ideas; cuando llegan se ha de luchar por ellas.

Zaha Hadid

muebles
GRUP **INTERMOBEL**



GRUPPA
muebles
INTERMOBEL



muebles
INTERMOBEL

*yoko, a versatile system
to make a difference*

86



87



▲ YOKO sistema modular, módulos y divisores en antracita mate, contenedores cerrados, contenedores abierto y estante escritorio en eucalipto ahumado, contenedor cristal dark grey / NUDOS mesa baja, tapa en blanco mate, estructura en metal negro / AMARA mesa, tapa en porcelánico duomo, estructura en nogal nut / MARIQUITA silla, funda tapizada en tela, estructura en metal negro.
YOKO modular system, matt antracita modules and dividers, eucalipto ahumado closed containers, open containers and desk shelf, dark grey glass showcase / NUDOS low table, matt blanco top cover, black metal structure / AMARA table, porcelain duomo top cover, nogal nut structure / MARIQUITA chair, upholstered fabric cover, black metal structure.

GRUPO **muebles**
INTERMOBEL

LOYRATIME

DAY COLLECTION



AMARA mesa, tapa en porcelánico duomo, estructura en nogal nut /
MARIQUITA silla, funda tapizada en tela, estructura en metal negro.
AMARA table, porcelain duomo top cover, nogal nut structure /
MARIQUITA chair, upholstered fabric cover, black metal structure.

GRUPO **muebles**
INTERMOBEL

LOYRATIME

DAY COLLECTION



NUDOS mesa baja, tapa en blanco mate, estructura en metal negro / WRAP sofá, tapizado en tela / POPPEA butaca, asiento tapizado en tela, estructura en metal negro.
 NUDOS low table, matt blanco top cover, black metal structure / WRAP sofa, upholstered in fabric / POPPEA armchair, fabric upholstered seat shell, black metal structure.

muebles
GRUPO INTERMOBEL



- ▲ YOKO sistema modular, módulos y divisores en arena mate, contenedores cerrados en nogal nut y lavanda mate, contenedor cristal transparente / Q3 contenedores a pared, estructura en nogal nut, frentes en arena mate.
YOKO modular system, matt arena modules and dividers, nogal nut and matt lavender closed containers, transparent glass showcase / Q3 wall container, nogal nut structure, matt arena fronts.
- BRICH mesa baja, estructura en roble humo, tapa en porcelánico duomo, patas en metal negro.
BRICH low table, roble humo structure, porcelain duomo top cover, black metal legs.



GRUPO **muebles**
INTERMOBEL



WRAP sofá tapizado en tela / LENE mesa baja, tapa y estructura en lavanda mate / DALEN mesa baja, tapa y estructura en lavanda mate.
 WRAP sofa upholstered in fabric / LENE low table, matt lavender top cover and structure / DALEN low table, matt lavender top cover and structure.

muebles
GRUPO INTERMOBEL



MOSS programa de contenedores, estructura exterior, puertas y cajones en nogal nut, estructura interior en antracita mate, puerta cristal dark grey metal negro, patas en metal negro / RHO mesa, estructura y tapa en antracita mate / OLE silla, asiento en nogal nut, base tapizada en tela, estructura en metal negro.
 MOSS container program, nogal nut outer structure, doors and drawers, matt antracita inner structure, dark grey glass door with black metal, black metal legs / RHO table, matt antracita structure and top cover / OLE chair, nogal nut seat shell, upholstered fabric base, black metal structure.





muebles
INTERMOBEL



- ▲ YOKO sistema modular, módulos tórtola mate, divisores en tórtola mate, arena mate, antracita mate y lavanda mate, contenedores cerrados en nogal nut, contenedores abiertos en antracita mate, contenedor cristal transparente / MOSS programa de contenedores, estructura exterior y puertas en lavanda mate, estructura interior en blanco mate, patas en metal negro / KONE mesa, tapa y estructura en blanco mate / TAIKO silla, asiento tapizado en tela, estructura en roble claro / DALEN mesa baja, tapa en nogal nut y antracita mate, estructura en metal negro / WRAP sofá, tapizado en tela / POPPEA butaca, asiento tapizado en tela, estructura en metal negro.
- YOKO modular system, matt tórtola modules, matt tórtola, matt arena, matt antracita and matt lavanda dividers, nogal nut closed containers, matt antracita open containers, transparent glass showcase / MOSS container program, matt lavanda outer structure and doors, matt blanco inner structure, black metal legs / KONE table, matt blanco top cover and structure / TAIKO chair, fabric upholstered seat, roble claro structure / DALEN low table, nogal nut and matt antracita top cover, black metal structure / WRAP sofa, upholstered in fabric / POPPEA armchair, fabric upholstered seat shell, black metal structure.

muebles
INTERMOBEL

102



MOSS programa de contenedores, estructura exterior y puertas en lavanda mate, estructura interior en blanco mate, patas en metal negro / DALEN mesa baja, tapa en nogal nut, y antracita mate, estructura en metal negro / WRAP sofá, tapizado en tela.
 MOSS container program, matt lavanda outer structure and doors, matt blanco inner structure, black metal legs / DALEN low table, nogal nut and matt antracita top cover, black metal structure / WRAP sofa, upholstered in fabric.

103



YOKO sistema modular, módulos tórtola mate, divisores en tórtola mate, arena mate, antracita mate y lavanda mate, contenedores cerrados en nogal nut, contenedores abiertos en antracita mate, contenedor cristal transparente.
 YOKO modular system, matt tórtola modules, matt tórtola, matt arena, matt antracita and matt lavanda dividers, nogal nut closed containers, matt antracita open containers, transparent glass showcase.

muebles
 GRUPO **INTERMOBEL**

LOYRATIME

DAY COLLECTION

104



KONE mesa, tapa y estructura en blanco mate / TAIKO silla, asiento tapizado en tela, estructura en roble claro.
KONE table, matt blanco top cover and structure / TAIKO chair, fabric upholstered seat, roble claro structure.

105



muebles
GRUPO **INTERMOBEL**

LOYRATIME

DAY COLLECTION



*The functional is better
than the beautiful,
because what works
well remains in time.*

Lo funcional es mejor que lo bello, porque lo
que funciona bien permanece en el tiempo.

Ray Eames

muebles
INTERMOBEL

muebles
GRUP **INTERMOBEL**



GRUPPO
INTERMOBEL



- ▲ IOS sistema modular, estructura y guía corredera en gris mate, puertas correderas en grafito brillo, cajones y cubo DEC en roble ceniza / DALEN mesa baja, tapa en gris mate, estructura en metal negro / WRAP sofá, tapizado en tela.
- IOS modular system, matt gris structure and sliding guide, high gloss grafito sliding doors, roble ceniza drawers and DEC cube / DALEN low table, matt gris top cover, black metal structure / WRAP sofa, upholstered in fabric.
- DALEN mesa baja, tapizado en tela, bandeja en metacrilato transparente.
DALEN low table, upholstered in fabric, transparent methacrylate tray.

GRUPO **muebles**
INTERMOBEL





GRUPPO
INTERMOBEL



▲ YOKO sistema modular, módulos y divisores en antracita mate, contenedor cerrado en roble humo, contenedor cristal dark grey, patas en metal negro / KONE mesa, tapa en antracita mate, estructura en metal negro / OLE silla, asiento tapizado en tela, estructura en roble humo / BRICH mesa baja, estructura en roble humo, tapa en porcelánico duomo, patas en metal negro / Q3 contenedores a pared, estructura en roble humo, frentes en tórtola mate / DALEN mesa baja, tapizado en tela, bandeja en metacrilato transparente / WRAP sofá, tapizado en tela.
 YOKO modular system, matt antracita modules and dividers, roble humo closed container, dark grey glass showcase, black metal legs / KONE table, matt antracita top cover, black metal structure / OLE chair, upholstered fabric seat shell, roble humo structure / BRICH low table, roble humo structure, porcelain duomo top cover, black metal legs / Q3 wall container, roble humo structure, matt tórtola fronts / DALEN low table, upholstered in fabric, transparent methacrylate tray / WRAP sofa, upholstered in fabric.

muebles
GRUPO INTERMOBEL



YOKO sistema modular, módulos y divisores en antracita mate, contenedor cerrado en roble humo, contenedor cristal dark grey, patas en metal negro / KONE mesa, tapa en antracita mate, estructura en metal negro / OLE silla, asiento tapizado en tela, estructura en roble humo.
 YOKO modular system, matt antracita modules and dividers, roble humo closed container, dark grey glass showcase, black metal legs / KONE table, matt antracita top cover, black metal structure / OLE chair, upholstered fabric seat shell, roble humo structure.

muebles
 GRUPO **INTERMOBEL**





MOSS programa de contenedores, estructura exterior, puertas y cajones en nogal nut, estructura interior en lavanda mate.
 MOSS container program, nogal nut outer structure, doors and drawers, matt lavanda inner structure.

muebles
GRUPO INTERMOBEL



muebles
GRUPPO **INTERMOBEL**



- ▲ IOS sistema modular, estructura y guía corredera en roble ceniza, puertas correderas y puerta abatible en grafito mate / BRICH mesa baja, estructura en roble ceniza, tapas en grafito mate y porcelánico paladio, patas en metal negro / WRAP sofá, tapizado en tela / POPPEA butaca, asiento tapizado en tela, estructura en metal negro.
 IOS modular system, roble ceniza structure and sliding guide, matt grafito sliding door and bottom hung door / BRICH low table, roble ceniza structure, matt grafito and porcelain paladio top cover, black metal legs / WRAP sofa, upholstered in fabric / POPPEA armchair, fabric upholstered seat shell, black metal structure.

muebles
GRUPO INTERMOBEL



► POPPEA butaca, asiento tapizado en tela, estructura en metal negro.
 POPPEA armchair, fabric upholstered seat shell, black metal structure.





GRUPPO
muebles
INTERMOBEL



- ▲ MOSS programa de contenedores, estructura exterior y puertas arena brillo, estructura interior tórtola mate, cajones grafito mate.
 MOSS container program, high gloss arena outer structure and doors, matt tórtola inner structure, matt grafito drawers.
- ◀ IOS sistema modular, estructura roble claro, puertas y panel tv. en arena mate, cajonera tv. en tórtola mate, cajones en caldera mate / BRICH mesa baja, estructura roble claro, tapa tórtola mate, patas en metal negro / TEMPLE sofá, tapizado en tela, estructura en metal negro / TINO butaca, tapizada en tela, estructura metal negro.
 IOS modular system, roble claro structure, matt arena doors and tv. panel, matt tórtola tv. drawer, matt caldera drawers / BRICH low table, roble claro structure, matt tórtola top cover, black metal legs / TEMPLE sofa, upholstered in fabric, black metal structure / TINO armchair, upholstered in fabric, black metal structure.

*La maison doit être
le cas de la vie, la
machine du bonheur.*

La casa debe ser el estuche de la vida, la máquina de la felicidad.

Le Corbusier

*Technical
information*

MOSS

programa de contenedores *container program*

design estudio Loyra

MOSS es un programa de contenedores pensado para configurar una pieza singular, bien como aparador, mueble tv o cualquier auxiliar. Cuenta con 5 medidas de ancho y 4 alturas, con la posibilidad de elegir entre 3 versiones de soporte: patas metálicas, suspendida o zócalo.

Se compone de una estructura exterior o forro que reviste a otra estructura interior siempre lacada mate. Cada contenedor elegido consta de espacios o huecos simétricos o asimétricos que pueden ser cubiertos por puertas, cajones o bien dejarse abiertos. MOSS es flexible, a la vez que singular.

MOSS is a container program designed to configure a singular piece, either as a sideboard, TV cabinet or any auxiliary.

It has 5 widths and 4 heights, with the possibility to choose between 3 versions of support: metal legs, suspended or plate base.

It consists of an exterior structure or lining that covers another interior structure always lacquered.

Each chosen container has symmetrical or asymmetric spaces or gaps that can be covered by doors, drawers or left open. MOSS is flexible, while unique.

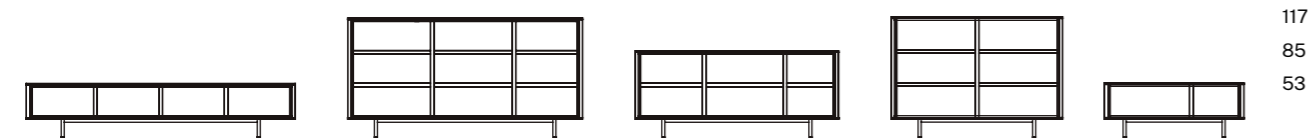

117
85
53

VERSION PATA METALICA METAL LEG VERSION

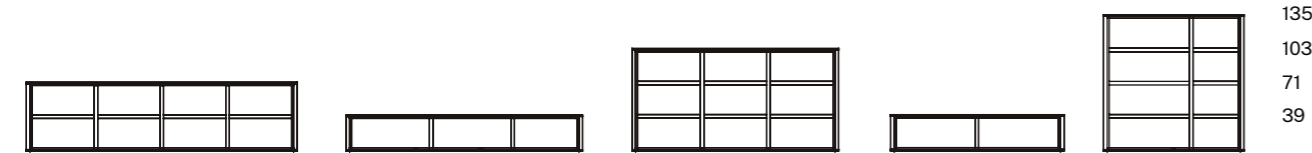

135
103
71
39

VERSION PATA ZOCALO PLATE BASE VERSION



99
67
35

VERSION PATA SUSPENDIDA SUSPENDED VERSION

263.5 231.5 199.5 167.5 135.5

acabados finishing

| | |
|--|---|
| ESTRUCTURA EXTERIOR OUTER STRUCTURE | madera (roble, nogal, eucalipto ahumado) wood (oak, walnut, smoked eucalyptus) laca mate o brillo (20 colores) matt or high gloss lacquer (20 colours) |
| ESTRUCTURA INTERIOR INNER STRUCTURE | laca mate (20 colores) matt lacquer (20 colours) |
| FRENTES MADERA WOODEN FRONTS | madera (roble, nogal, eucalipto ahumado) wood (oak, walnut, smoked eucalyptus) laca mate o brillo (20 colores) matt or high gloss lacquer (20 colours) |
| FRENTES CRISTAL GLASS FRONTS | metal negro o lacado mate (20 colores) + cristal transparente o ahumado black metal or matt lacquer (20 colours) + transparent or dark grey glass |
| PATAS METAL LEGS | metal negro o lacado mate (20 colores) black metal or matt lacquer (20 colours) |



COMP 1 L135.5 H135 F44 cm
Acabados estructura exterior y puertas arena brillo · estructura interior tórtola mate · cajones grafito mate
Finishing outer structure and doors high gloss arena · inner structure matt tórtola · drawers high gloss grafito



COMP 2 L199.5 H117 F44 cm
Acabados estructura exterior, puertas y cajones gris brillo · estructura interior blanco mate · patas y tiradores metal laca blanco mate
Finishing outer structure, doors and drawers high gloss gris · inner structure matt blanco · legs and handle metal lacquer matt blanco



COMP 3 L263.5 H53 F44 cm
Acabados estructura exterior, puertas y cajones roble ceniza · estructura interior arena mate · puerta cristal dark grey, metal negro · patas y tiradores metal negro
Finishing outer structure, doors and drawers roble ceniza · inner structure matt arena · dark grey glass door, metal negro · legs and handles metal negro



COMP 4 L263.5 H85 F44 cm
Acabados estructura exterior, puertas y cajones grafito brillo · estructura interior blanco mate · patas metal negro
Finishing outer structure, doors and drawers high gloss grafito · inner structure matt blanco · legs metal negro



COMP 5 L199.5 H85 F44 cm
Acabados estructura exterior, puertas y cajones roble ceniza · estructura interior tórtola mate · puerta cristal dark grey metal negro · patas y tiradores metal negro
Finishing outer structure, doors and drawers roble ceniza · inner structure matt tórtola · dark grey glass door black metal · legs and handles black metal



COMP 6 L263.5 H35 F44 cm
Acabados estructura nogal nut · estructura interior lavanda mate · puertas nogal nut · cajones nogal nut
Finishing nogal nut outer structure · matt lavanda inner structure · nogal nut doors · nogal nut drawers

muebles
INTERMOBES

YOKO

sistema modular *modular system*

design Ximo Roca

YOKO es un sistema de módulos que pueden unirse entre sí creando una composición o tratarse individualmente obteniendo una pieza singular. Los módulos pueden ser completados añadiendo contenedores con puertas, cajones o vitrinas, y divisores verticales. La peculiaridad del diseño radica en la posibilidad de alterar la posición de los contenedores y divisores en cualquier momento, convirtiéndose así en una pieza dinámica. YOKO es movimiento, cambia contigo cada vez que lo desees. *YOKO is a modular system that can be assembled creating a composition or used individually obtaining a singular piece. The modules can be completed by adding containers with doors, drawers or showcases, and vertical dividers. The peculiarity of the design lies in the possibility of changing the position of the containers and dividers at any time, becoming a dynamic piece. YOKO is movement, it changes with you whenever you want.*

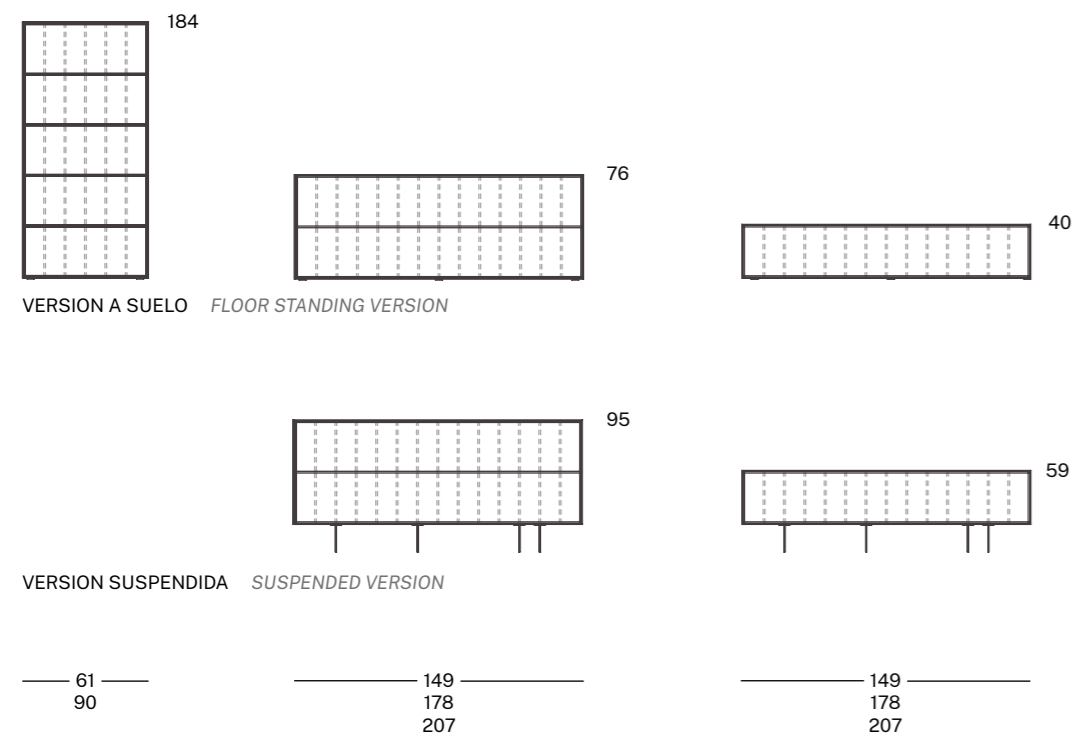

acabados *finishing*

| | |
|--|--|
| MÓDULOS Y DIVISORES <i>MODULES AND DIVIDERS</i> | laca mate (20 colores) <i>matt lacquer (20 colours)</i> |
| CONTENEDORES <i>CONTAINERS</i> | madera (roble, nogal, eucalipto ahumado) <i>wood (oak, walnut, smoked eucalyptus)</i> laca mate (20 colores) <i>matt lacquer (20 colours)</i> |
| CONTENEDOR DE CRISTAL <i>SHOWCASE CONTAINER</i> | crystal transparente o dark grey <i>transparent or dark grey glass</i> |
| ESTANTE ESCRITORIO <i>DESKTOP SHELF</i> | madera (roble, nogal, eucalipto ahumado) <i>wood (oak, walnut, smoked eucalyptus)</i> laca mate (20 colores) <i>matt lacquer (20 colours)</i> |
| PATAS <i>METAL LEGS</i> | metal negro o lacado mate (20 colores) <i>matt lacquer (20 colours)</i> |

muebles
GRUPO **INTERMOBES**



COMP 1 L540 H184 F32/60 cm
Acabados módulos visón mate · divisores visón, arena, antracita, lavanda mate · contenedores nogal nut/grafito mate · contenedores cristal transparente
Finishing modules matt visón · dividers matt visón, arena, antracita, lavanda · containers nogal nut/matt grafito · transparent showcase container



COMP 2 L480 H184 F32/60 cm
Acabados módulos y divisores antracita mate · contenedores eucalipto ahumado · contenedor cristal dark grey
Finishing modules and dividers matt antracita · containers eucalipto ahumado · showcase container dark grey



COMP 3 L270 H184 F32/50 cm
Acabados módulos y divisores blanco mate · contenedores y estante escritorio roble claro · contenedor cristal dark grey
Finishing modules and dividers matt blanco · containers and desktop shelf roble claro · dark grey showcase container



COMP 4 L174x2 H59 F32/40 cm
Acabados módulos y divisores gris mate · contenedores roble claro · contenedor cristal dark grey
Finishing modules and dividers matt gris · containers roble claro · dark grey showcase container



COMP 5 L207x2 H405 F32/40 cm
Acabados módulos gris, arena mate · divisores gris, arena, lavanda mate · contenedores nogal nut, lavanda mate · contenedor transparente
Finishing modules matt gris, arena · dividers matt gris, arena, lavanda · containers nogal nut, matt lavanda · transparent showcase container



COMP 6 L178 H95 F35 cm
Acabados módulos y divisores antracita mate · contenedor roble humo · contenedor cristal transparente
Finishing modules and dividers matt antracita · container roble humo · transparent showcase container

Q

contenedores a pared *wall containers*

design estudio Loyra

Q es un programa de cubos que pueden ser usados de forma independiente o bien en conjunto creando infinitas composiciones. Existen 3 versiones: Q1 (abierto), Q2 y Q3 (cerrados con distintas opciones de puertas y cajones), que partiendo de una medida mínima, estas crecen de 5 en 5 centímetros en ancho, altura y profundidad. Desde una mesita de noche hasta la composición de una gran librería, acompañando otras piezas o protagonista singular, Q aporta versatilidad sin límite.

Q is a "cubes" program that can be used independently or together creating endless compositions.

There are 3 versions: Q1 (open), Q2 and Q3 (closed with different options of doors and drawers), starting from a minimum measure, growing these 5 in 5 centimeters in width, height and depth.

From a bedside table to the composition of a large bookshop, accompanying other pieces or singular protagonist, Q brings unlimited versatility.

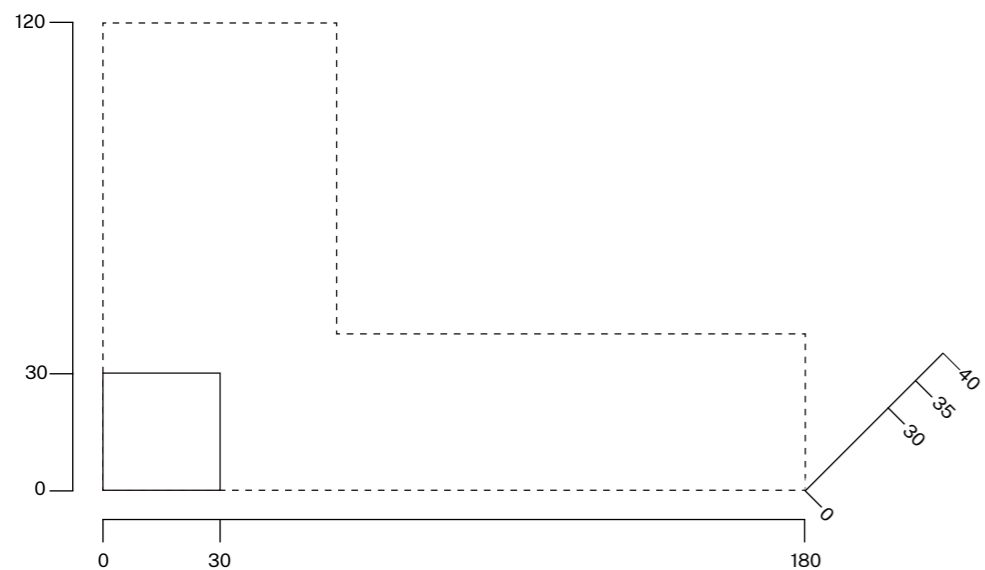
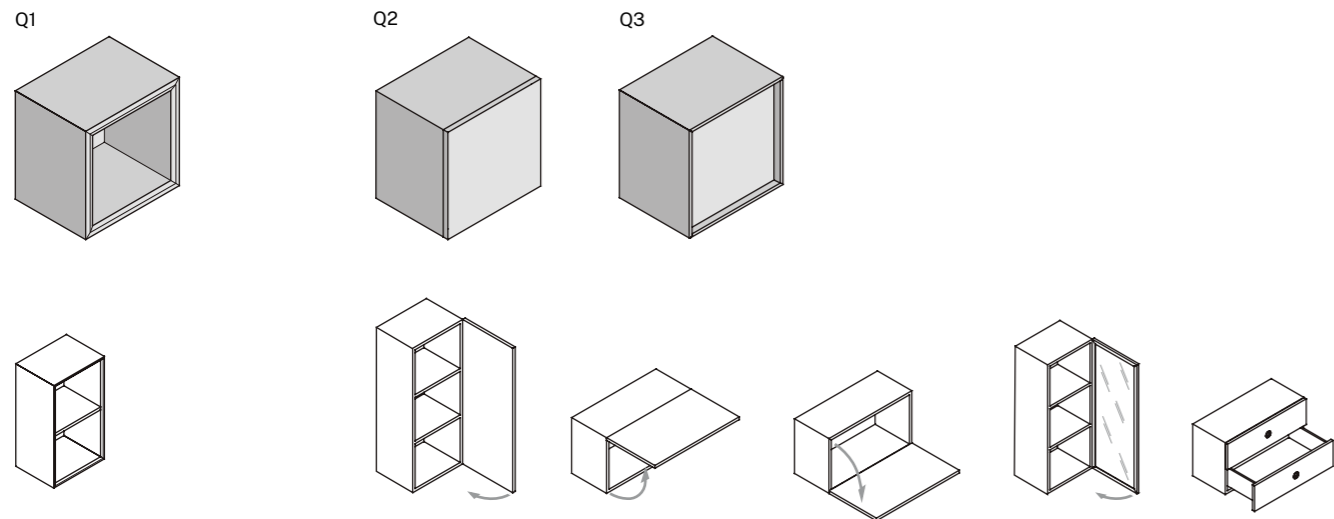

acabados *finishing*

| | |
|---------------------------------|--|
| ESTRUCTURA STRUCTURE | madera (roble, nogal, eucalipto ahumado) <i>wood (oak, walnut, smoked eucalyptus)</i> laca mate (20 colores) <i>matt lacquer (20 colours)</i> |
| FRENTES MADERA WOODEN FRONTS | Q2: mismo acabado que estructura <i>same finish as structure</i> Q3: laca mate (20 colores) <i>matt lacquer (20 colours)</i> |
| FRENTES CRISTAL GLASS FRONTS | Q2, Q3: metal negro o lacado mate (20 colores) + cristal transparente o dark grey <i>black metal or matt lacquer (20 colours) + transparent or dark grey glass</i> |

muebles
GRUP
INTERMOBIL



COMP 1 Q3 + Brich
Acabados estructuras roble humo · frentes tórtola mate
Finishing structures roble humo · fronts matt tórtola



COMP 2 Q1, Q2
Acabados estructuras y frentes polvo, tinta mate
Finishing structures and fronts matt polvo, tinta



COMP 3 Q1, Q2
Acabados estructuras y frentes roble humo, cactus mate · frentes cristal transparente metal negro
Finishing structures and fronts roble humo, matt cactus · fronts transparent glass, metal negro



COMP 4 Q1, Q2
Acabados estructuras y frentes nogal nut, visión mate
Finishing structures and fronts nogal nut, matt visión

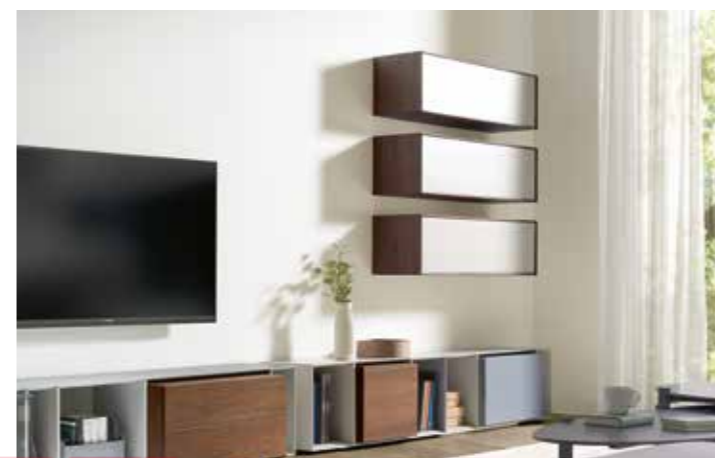

COMP 5 Q3 + Yoko
Acabados estructuras nogal nut · frentes arena mate
Finishing structures nogal nut · fronts matt arena



COMP 6 Q3
Acabados estructuras nogal nut · frentes blanco mate
Finishing structures nogal nut · fronts matt blanco

mesas tables



KONE design Ximo Roca Diseño
acabados / finishing
estructura: metal negro o lacado mate (20 colores)
tapa: madera (roble, nogal, eucalipto ahumado) / laca mate anti-scratch (20 colores)
structure: black metal or matt lacquer (20 colours)
top: wood (oak, walnut, smoked eucalyptus) / anti-scratch matt lacquer (20 colours)

medidas / dimensions
L160 F90 H75
L220 F100 H75
Ø125 H75



VESTA design Ximo Roca Diseño
acabados / finishing
estructura: metal negro o lacado mate (20 colores)
tapa: madera (roble, nogal, eucalipto ahumado) / laca mate anti-scratch (20 colores)
structure: black metal or matt lacquer (20 colours)
top: wood (oak, walnut, smoked eucalyptus) / anti-scratch matt lacquer (20 colours)

medidas
L180 F90 H75



AMARA design estudio Loyra
acabados / finishing
estructura: madera (roble, nogal)
tapa: porcelánico (duomo, paladio) / laca mate anti-scratch (20 colores)
structure: wood (oak, walnut)
top: porcelain (duomo/paladio) / matt anti-scratch lacquer (20 colours)

medidas / finishing
L180 F100 H75
L240 F100 H75



RHO design Abad diseño
acabados / finishing
estructura y tapa: madera (roble, nogal, eucalipto ahumado) / laca mate anti-scratch* (20 colores) *tratamiento anti-scratch sólo en tapa
structure and top: wood (oak, walnut, smoked eucalyptus) / anti-scratch* matt lacquer (20 colours) *anti-scratch finish only in the top cover

medidas / finishing
L145 F95 H75
L170 F95 H75

sillas chairs



MARIQUITA design Ximo Roca Diseño
acabados / finishing
estructura: metal negro o lacado mate (20 colores)
asiento: polipropileno (4 colores) + opcional funda tapizada
structure: black metal or matt lacquer (20 colours)
seat shell: polypropylene (4 colours) + optional upholstered cover

medidas / dimensions
L60 F56 H79



POPPEA design Ximo Roca Diseño
acabados / finishing
estructura: metal negro o lacado mate (20 colores)
asiento: polipropileno (4 colores) + opcional base tapizada
structure: black metal or matt lacquer (20 colours)
seat shell: polypropylene (4 colours) + optional upholstered base

medidas / dimensions
L55 F54 H80



TAIKO design Ximo Roca Diseño
acabados / finishing
estructura: madera (roble, nogal) o laca mate (20 colores)
asiento: tapizado
structure: wood (oak, walnut) or matt lacquer (20 colours)
seat shell: upholstered

medidas / dimensions
L52 F55 H73



ROA design Ximo Roca Diseño
acabados / finishing
estructura: madera roble o laca mate (20 colores)
asiento: tapizado
structure: oak wood or matt lacquer (20 colours)
seat shell: upholstered

medidas / dimensions
L48 F56 H76



OLE design Ximo Roca Diseño
acabados / finishing
estructura: - metálica: metal negro o lacado mate (20 colores)
- giratoria: metal negro o lacado mate (20 colores)
- madera: roble, nogal / lacado mate (20 colores)
asiento: - madera: roble, nogal + opcional base tapizada
- polipropileno (4 colores) + opcional base tapizada
- tapizado
structure: - metal: black metal or matt lacquer (20 colours)
- revolving base: black metal or matt lacquer (20 colours)
- wood: oak, walnut / matt lacquer (20 colours)
seat shell: - wood: oak, walnut + optional upholstered base
- upholstered

medidas / dimensions
L60 F57/54/56 H79

mesas bajas *low tables*



NUDOS design Ximo Roca Diseño
acabados / finishing
estructura: metal negro o lacado mate (20 colores)
tapa: laca mate anti-scratch (20 colores)
structure: black metal or matt lacquer (20 colours)
top: anti-scratch matt lacquer (20 colours)

medidas / dimensions
L113 F63 H32
L95 F95 H32



LENE design Ximo Roca Diseño
acabados / finishing
estructura: madera (roble, nogal) o lacado mate (20 colores)
tapa: madera (roble, nogal) / laca mate anti-scratch (20 colores)
structure: wood (oak, walnut) or matt lacquer (20 colours)
top cover: wood (oak, walnut) / anti-scratch matt lacquer (20 colours)

medidas
Ø100 H40
Ø60 H32
L180 F60 H32



DALEN design Ximo Roca Diseño
acabados / finishing
estructura: metal negro o lacado mate (20 colores)
tapa: madera (roble, nogal) / laca mate anti-scratch (20 colores)
structure: black metal or matt lacquer (20 colours)
top: wood (oak, walnut) / anti-scratch matt lacquer (20 colours)

medidas / dimensions
L110 F50 H32
L90 F30 H45



DALEN design Ximo Roca Diseño
acabados / finishing
estructura: tapizada
bandeja: metacrilato transparente
structure: upholstered
tray: transparent methacrylate

medidas / dimensions
L120 F70 H32



BRICH design estudio Loyra
acabados / finishing
patas: metal negro o laca mate (20 colores)
estructura: madera (roble, nogal, eucalipto a.) / laca mate (20 colores)
tapa: porcelánico (duomo, paladio) / laca mate anti-scratch (20 colores)
legs: black metal or matt lacquer (20 colours)
structure: wood (oak, walnut, smoked eucalyptus) / matt lacquer (20 colours)
top cover: porcelain (duomo, paladio) / anti-scratch matt lacquer (20 colours)

medidas / dimensions
bancada tv
L180 F45 H35
L230 F45 H35
L280 F45 H35
mesa auxiliar
L120 F60 H30
L100 F100 H30
L80 F30 H45
L70 F70 H45

butacas *armchairs*



POPPEA design Ximo Roca Diseño
acabados / finishing
estructura: metal negro o lacado mate (20 colores)
asiento: tapizado
structure: black metal or matt lacquer (20 colours)
seat shell: upholstered

medidas / dimensions
butaca baja
low armchair
L87 F75 H80



TINO balancín design Ximo Roca Diseño
acabados / finishing
estructura: madera (roble, nogal) o lacado mate (20 colores)
+ metal negro o lacado mate (20 colores)
asiento: tapizado
structure: madera (roble, nogal) o lacado mate (20 colores) + metal negro o lacado mate (20 colores)
seat: upholstered

medidas / dimensions
L76 F84 H84



POPPEA design Ximo Roca Diseño
acabados / finishing
estructura: metal negro o lacado mate (20 colores)
asiento: tapizado
structure: black metal or matt lacquer (20 colours)
seat shell: upholstered

medidas / dimensions
butaca alta
high armchair
L92 F82 H126



TINO patas design Ximo Roca Diseño
acabados / finishing
estructura: metal negro o laca mate (20 colores)
asiento: tapizado
structure: black metal or matt lacquer (20 colours)
seat: upholstered

medidas / dimensions
L76 F84 H84

muebles
GRUPO **INTERMOBEL**



WRAP design Ximo Roca Diseño
 acabados / finishing
 estructura: madera maciza recubierta de poliuretano
 almohadones: poliuretano foamizado con distintas densidades
 structure: solid wood covered with polyurethane
 cushions: foamized polyurethane with different densities

medidas / dimensions

Brazo
 Arm

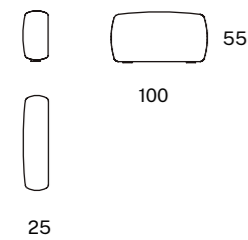

Módulos
 Modules

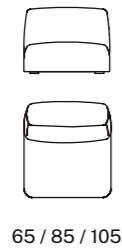

Módulo remate izquierda / derecha
 Left end module / right end module

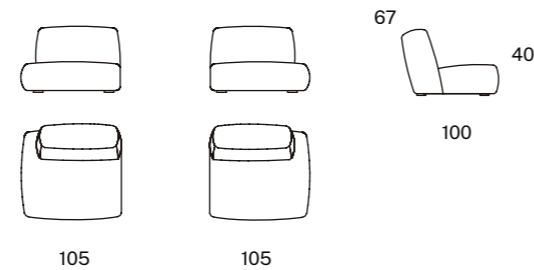

Módulo chaiselongue
 Chaiselongue module

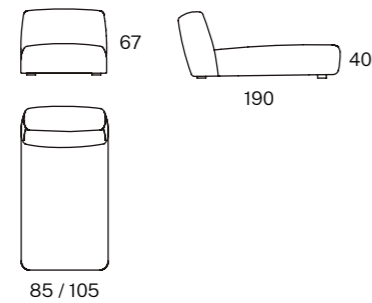

Módulo ángulo
 Angle module

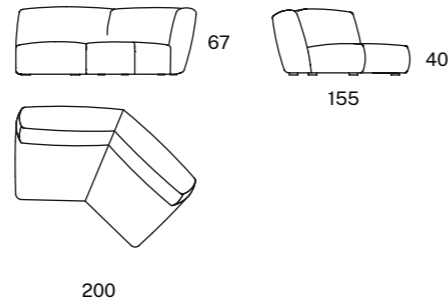

WRAP zócalo design Ximo Roca Diseño
 acabados / finishing
 estructura: madera maciza recubierta de poliuretano
 almohadones: poliuretano foamizado con distintas densidades
 structure: solid wood covered with polyurethane
 cushions: foamized polyurethane with different densities

medidas / dimensions

Brazo
 Arm

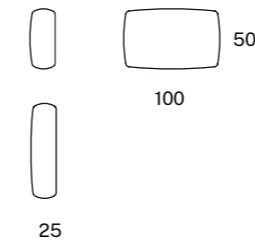

Módulos
 Modules

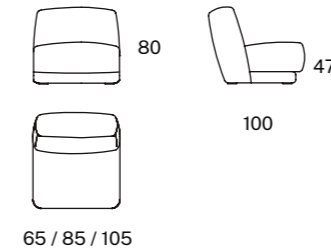

TEMPLE design Ximo Roca Diseño
 acabados / finishing
 estructura: madera maciza recubierta de poliuretano
 almohadones: poliuretano foamizado con distintas densidades
 patas: metal negro o lacado mate (20 colores)
 structure: solid wood covered with polyurethane
 cushions: foamized polyurethane with different densities
 legs: black metal or matt lacquer (20 colours)

medidas / dimensions

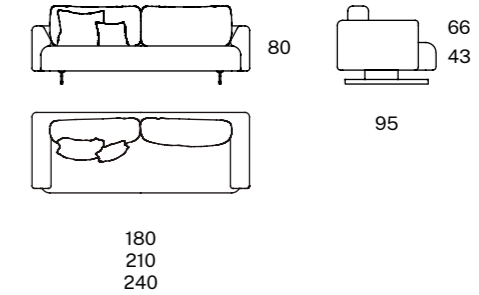

acabados *finishing*

metal *metal*

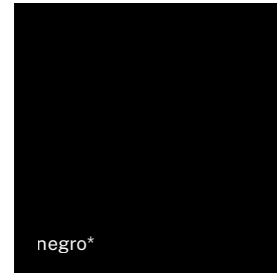

* opción laca mate (20 colores)
optional matt lacquer (20 colours)

cristal *glass*

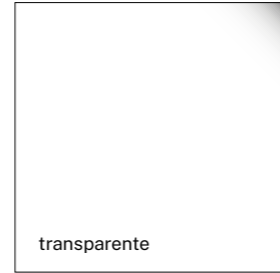

polipropilenos *polypropilenes*

OLE chair

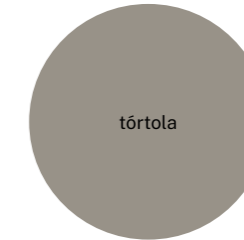
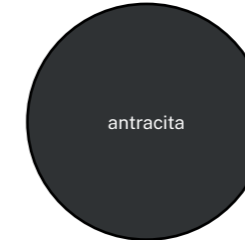
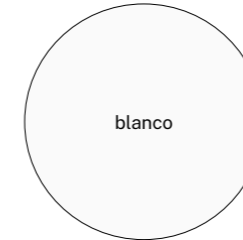

MARIQUITA chair

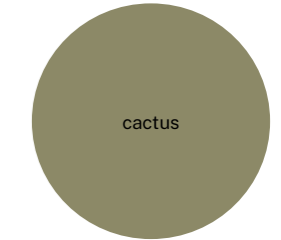
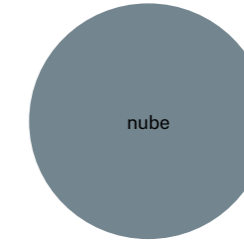
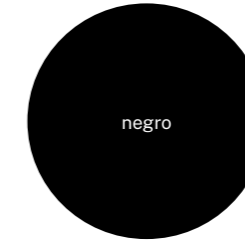
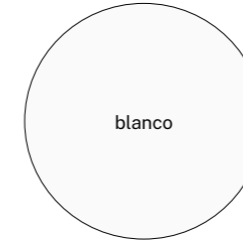

POPPEA chair

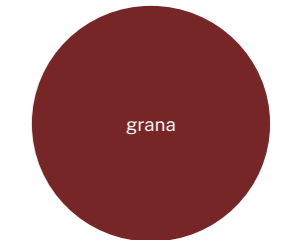
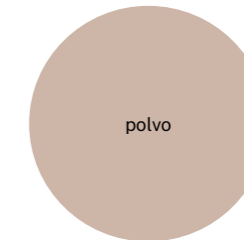
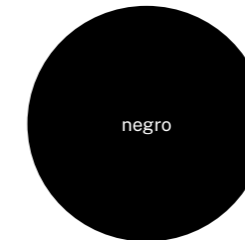
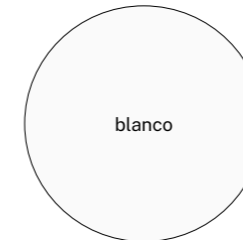

lacas (mate / brillo) *lacquers (matt / high gloss)*

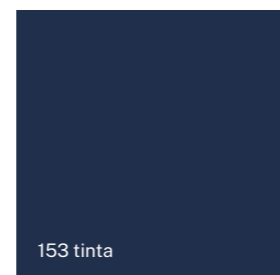
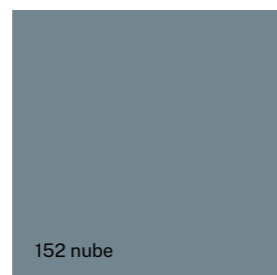
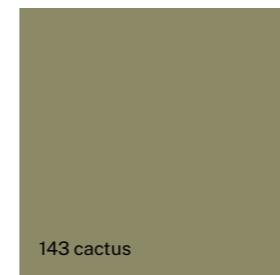
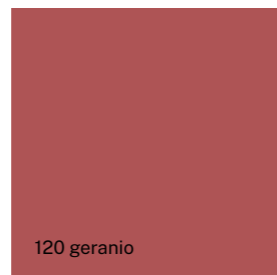
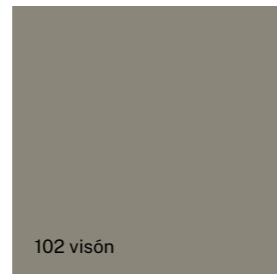
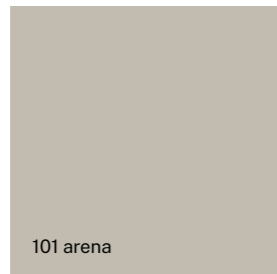
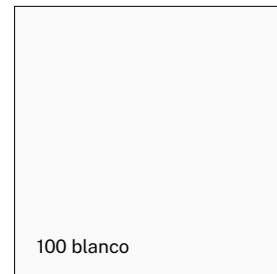

porcelánicos *porcelain*



maderas *woods*



GRUPPO **muebles**
INTERMOBEL

alfombras *carpets*

medidas / dimensions

opciones estándar: 240 x 160 / 280 x 200 cm

a medida: largo sin límites x 4 m de ancho

standard options: 240 x 160 / 280 x 200 cm

custom made up to 4 meters wide



crudo



gris



antracita

Diseño Gráfico_Graphic Design
Ximo Roca Diseño

Fotografía_Photography
Vertice Fotógrafos

Impresión_Printed by
Logik Graphics

Creaciones Loyra S.L.

Argenters, 21 - Pol. Ind. L'Alter
Apdo. de Correos, 111
46290 Alcàsser, Valencia - Spain

www.loyratime.com

CREACIONES LOYRA © 2019

Reservados todos los derechos. Esta publicación no puede ser copiada total o parcialmente por cualquier medio sin previa autorización del editor. Todos los modelos están protegidos mediante patente internacional.

All rights reserved. This publication may not be reproduced in whole or in part in any manner whatsoever without the permission of the publisher. All models are protected by international patent.

GRUPO
muebles
ALTERMOBEL