

# GiveMeFive!

by artemader®



INTERMOBEL



## ¿Quiénes somos?

En Artemader somos diseñadores y fabricantes de mueble juvenil y senior desde 1986.

Durante esos años nos hemos adaptado a las nuevas necesidades de espacio, al deseo de disfrutar las zonas de descanso y transformando esos deseos procedentes del mundo de los niños y los padres, en productos fieles a los principios de la creatividad y la calidad.

Aunamos la experiencia de llevar más de 30 años fabricando con la ventaja de estar situados en una de las mayores zonas de fabricación del mueble, como es Valencia.

## Nuestra Filosofía

Diseño, calidad, tecnología y servicio son los pilares de Artemader.

Estos aspectos hablan de la historia de la empresa, que han contribuido a hacer una compañía sólida y dinámica desde hace más de 30 años. Esta filosofía ha hecho que la combinación entre artesanía y tecnología, el cuidado del detalle y la protección del medio ambiente estén todos comunicados entre sí para conseguir una empresa puntera, acorde a los tiempos que corren.

## About us

*At Artemader we have been designers and manufacturers of youth and senior furniture since 1986.*

*During those years we have adapted to the new needs of space, the desire to enjoy the rest areas and transforming those desires from the world of children and parents into products that are faithful to the principles of creativity and quality.*

*We have the experience of more than 30 years manufacturing with the advantage of being located in one of the biggest areas of furniture manufacturing, such as Valencia.*

## Our Philosophy

*Design, quality, technology and service are the pillars of Artemader.*

*These aspects speak of the history of the company, which have contributed to making a solid and dynamic company for more than 30 years. This philosophy has made the combination of craftsmanship and technology, care of detail and protection of the environment are all communicated with each other to achieve a leading company, according to the times that run.*

# Colecciones

**matt**  
collection

P.02  
P.41

**pirineos**  
collection

P.44  
P.64

**camarote**  
collection

P.65  
P.76

Give  
Me  
Five!

by artemader®

muebles  
**GRUPO INTERMOBEL**



**“Bienvenidos a mi cuarto”**

Los dormitorios son el espacio personal de nuestros hijos. Allí van a jugar, estudiar y descansar. Descubre el estilo nórdico que llega desde el Mediterráneo.

**“Welcome to my room”**

The bedrooms are the personal space of our children. There they will play, study and rest. Discover the Nordic style that comes from the Mediterranean.

# **matt**

collection

DISEÑO NÓRDICO  
NORDIC DESIGN



artemader®

# 01.matt

**BASE**      **COMBINADO**

haya natural      blanco

**PATAS**      **SOBRE**

pizarra      blanco





## 02.matt

**BASE**  
 haya natural

**COMBINADO**  
 blanco    amarillo

**ESTANTERÍA**  
 verde





### 03.matt





## 04.matt

BASE



haya natural

COMBINADO

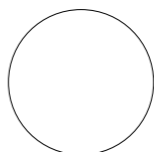

blanco







muebles  
**INTERMOBEL**

## 05.matt

BASE



haya natural

COMBINADO

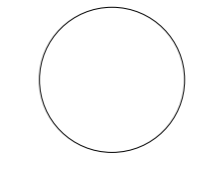

blanco

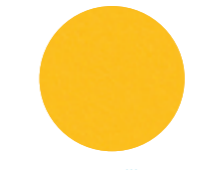

amarillo



# 06.matt

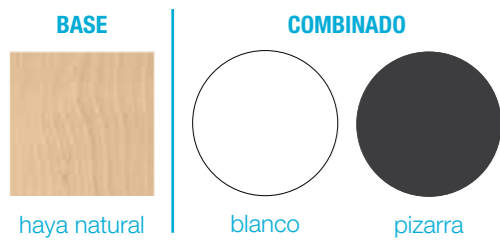

matt



## 07.matt

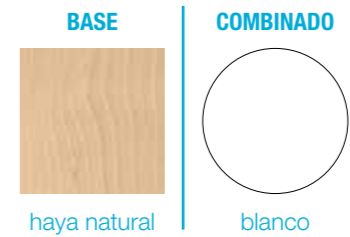



muebles  
**INTERMOBEL**

## 08.matt

BASE



haya natural

COMBINADO

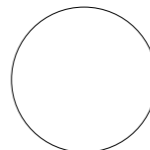

blanco



verde



# 09.matt

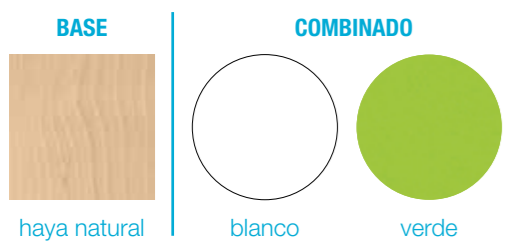

# 10.matt

- |   |   |
|---|---|
| <b>BASE</b>   | <b>COMBINADO</b>  |
|  |  |
| haya natural  | blanco  |
|   |  |
|   | azul glacial  |
|   |  |
|   | naranja   |



muebles  
**INTERMOBEL**



# matt

collection

Libertad,  
es la  
capacidad  
de la  
conciencia  
para pensar  
y obrar  
según la  
propia  
voluntad de  
la persona.

artemader®

GiveMeFive!



11.matt

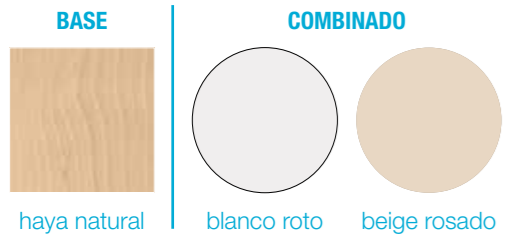

Detalle arcón abierto.





# 12.matt

BASE



haya natural

COMBINADO

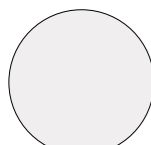

blanco roto



amarillo





muebles  
**INTERMOBEL**

### 13.matt

**BASE** **COMBINADO**

haya natural blanco roto

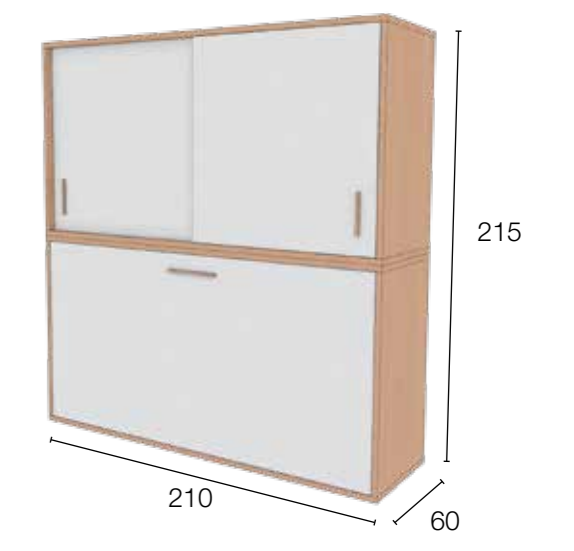
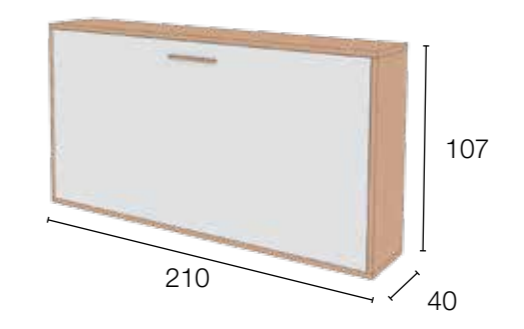



BASE

COMBINADO

haya natural    blanco    naranja



muebles  
**INTERNOBEL**

# 15.matt

**BASE** **COMBINADO**

haya natural fresno casino beige rosado

**MESA** **SILLA**

haya natural blanco



"arquitectur"



"oslo"



muebles  
**INTERMOBEL**

## 16.matt

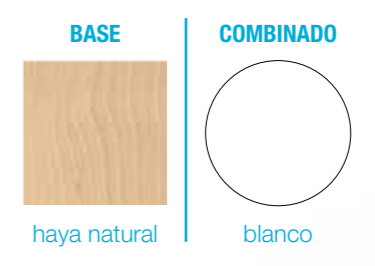

# 17.matt

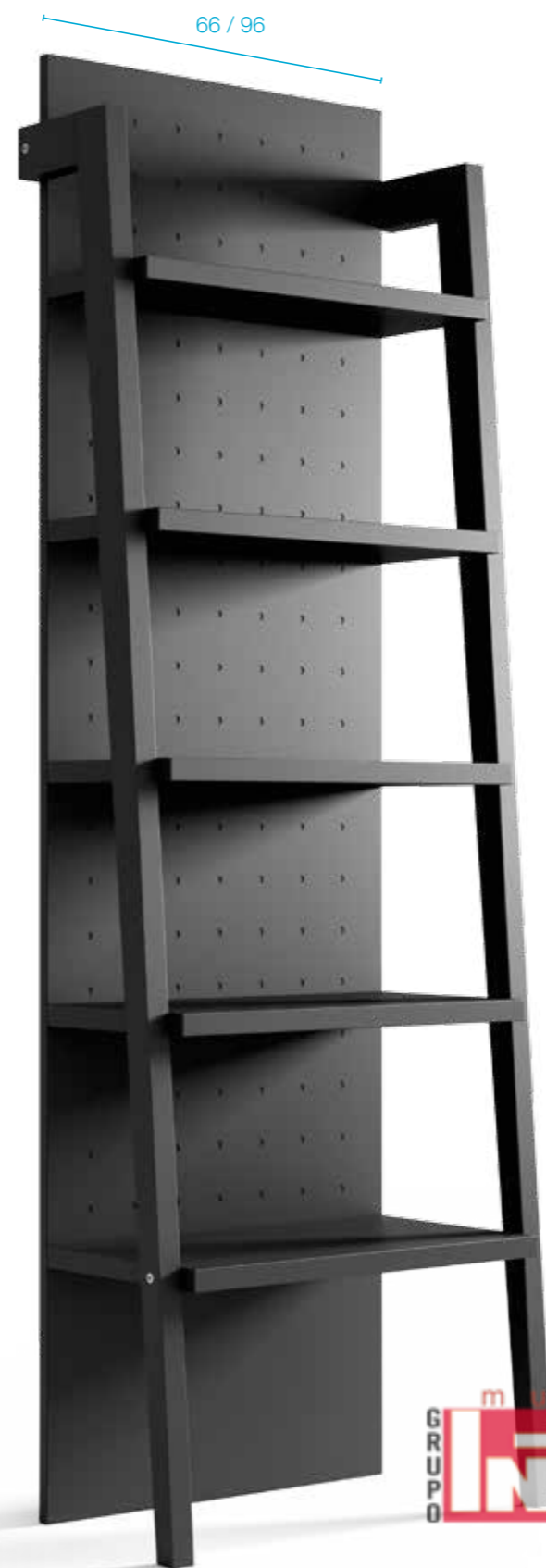
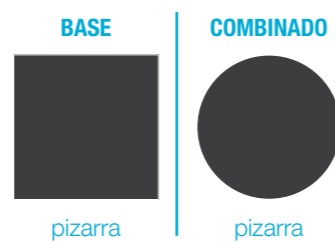
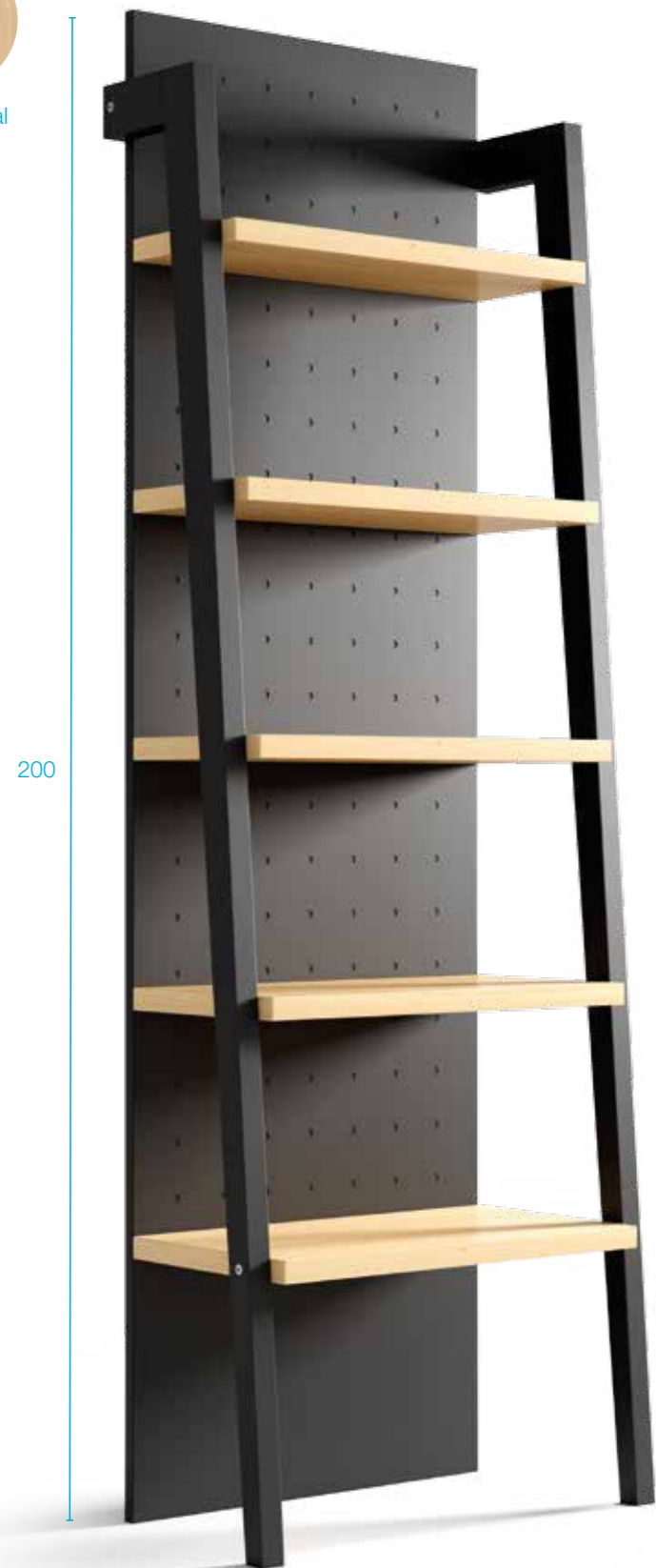

muebles  
**INTERMOBEL**

# 18.matt





litera 2 camas  
[ 200 largo x 185 alto ]



litera / escritorio

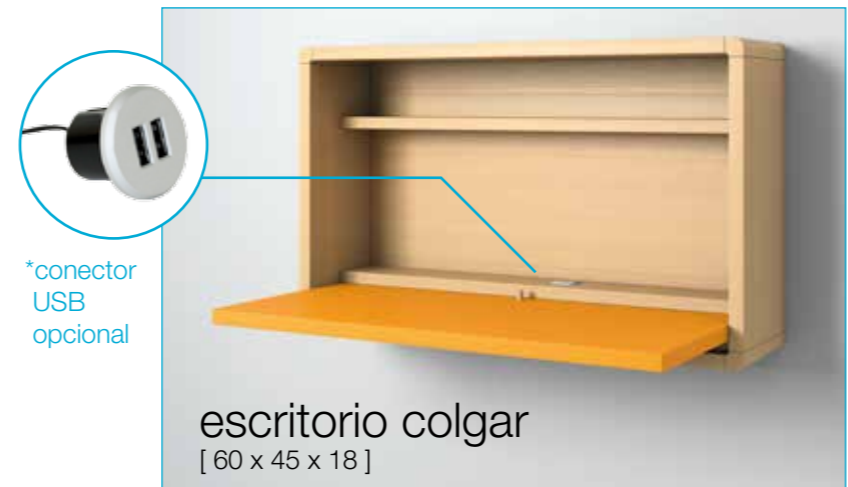

escritorio colgar  
[ 60 x 45 x 18 ]

# GiveMeFive!

by artemader®



estantería  
[ 160 x 90 x 30 ]



[detalle cabecero]



camá "tribeca"  
[ 212 largo x 102 alto ]



cómoda  
[ 90/110 ancho x 83 alto ]



escritorio a pared  
[ 55 fondo ]

muebles  
**INTERMOBIL**

aparador / buffet  
[ 180 x 45 x 82 alto ]



mesa estudio "Amsterdam"  
[ 180 x 90 ]



cama [cajones] "Alpes"  
[ 203 x 98 x 95/56 alto ]



cama [nido] "Oslo"  
[ 200 x 98 x 95/56 alto ]



escritorio  
[ 55 fondo ]



sillería

# GiveMeFive! by artemader®



"oslo"



"matt"

cama [nido con trasera] "Matt"  
[ 200 x 98 x 75 alto ]



cama [nido]  
[ 200 x 98 x 75/56 alto ]



muebles  
**INTERMOBEL**



“Estilo de antaño.  
Estética de hoy.”

Dormitorios juveniles  
de estilo vintage,  
que satisfacen la necesidad  
de funcionalidad del día a día.  
Diseño fresco y elegante.

“*Style of yesteryear.  
Aesthetics of today.*”

*Juvenile vintage-style bedrooms,  
which meet the need  
for day-to-day functionality.  
Cool and elegant design.*

# pirineos

collection

ESTILO “LOUIS PHILIPPE”  
“LOUIS PHILIPPE” STYLE

muebles  
**INTERMOBEL**

artemader®

# 01.pirineos



## 02.pirineos

BASE      COMBINADO

blanco      beige rosado



### 03.pirineos



"dama"



muebles  
**INTERMOBEL**

# 04.pirineos

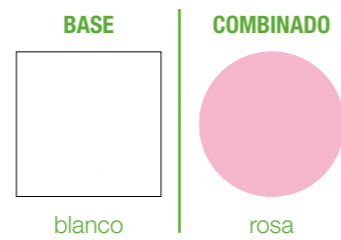

# pirineos

collection

Amigos,  
personas con  
las cuales  
la lealtad y  
confianza es  
mutua, se  
escuchan,  
saben cuando  
callar y brindar  
su apoyo.

artemader®

GiveMeFive!



muebles  
**INTERMOBEL**

# 05.pirineos



# 06.pirineos

BASE      COMBINADO

blanco      haya natural

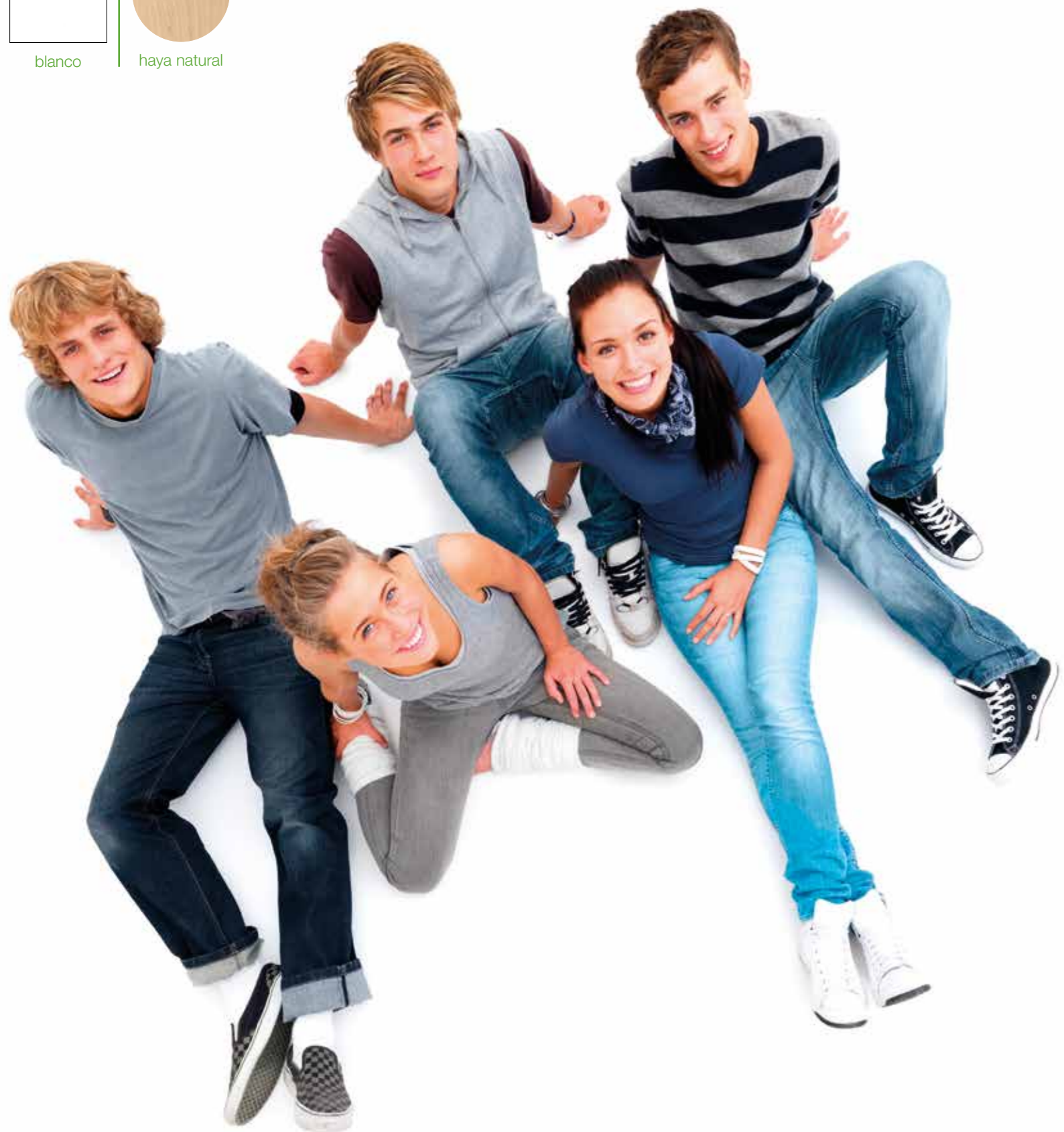



muebles  
**INTERMOBEL**

“spring”





## 07.pirineos

BASE	COMBINADO
	
blanco	haya natural



muebles  
**INTERMOBEL**

BASE



fresno casino

Dormitorio realizado  
en madera de fresno.

*Bedroom made  
of ash wood.*





“Mónaco”  
collection



muebles  
**INTERMOBEL**



**camarote**  
collection

DISEÑO ESTILO NAÚTICO  
NAUTICAL STYLE DESIGN

“La Belleza del Océano”  
Los mares cubren el 70%  
de la superficie de la Tierra.  
Su encanto y el de sus criaturas  
nos llenan de paz y serenidad.  
Nuestro mueble náutico  
que te transporta al océano.  
¡Déjate llevar!

“The Beauty of the Ocean”  
The seas cover 70%  
of the Earth's surface.  
Its charm and that of its creatures  
fill us with peace and serenity.  
Our nautical furniture  
that transports you to the ocean.  
Let yourself go!

**artemader®**

# 01.camarote

BASE



camarote nº3



INTERMOBEL



## 02.camarote

BASE



camarote n°3





03.camarote

BASE



camarote nº3



# camarote

c o l l e c t i o n

Aventura,  
es una  
experiencia  
de naturaleza  
arriesgada  
normalmente  
compuesta  
de eventos  
inesperados,  
estando  
presente cierta  
clase de peligro.

artemader®

GiveMeFive!



# 04.camarote

BASE



blanco nº15







**Give  
Me  
Five!**

muebles  
**INTERMOBEL**

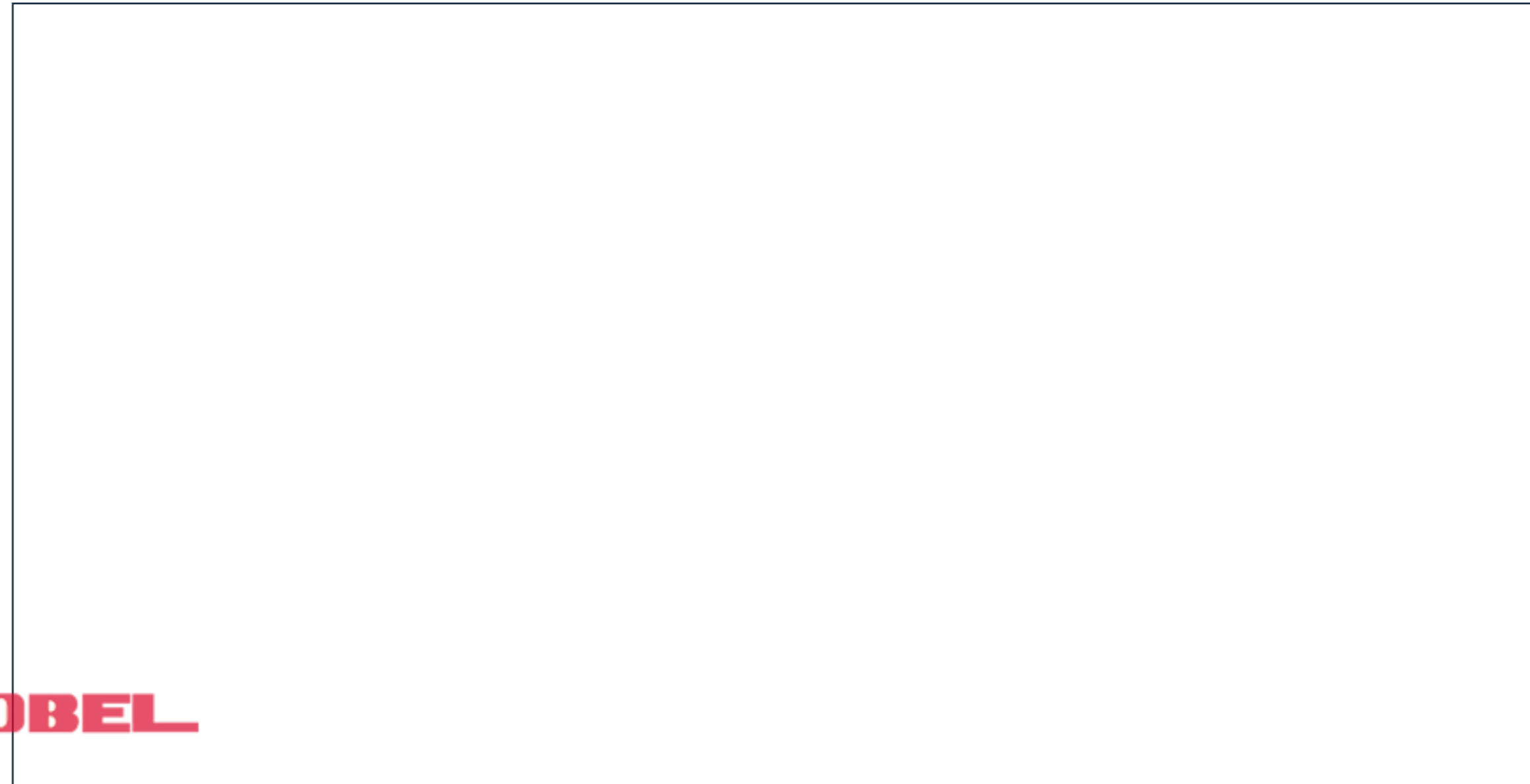

## ARTEMADE, S.L.

C/ La Farola, 6  
46760 TAVERNES DE VALLDIGNA  
(Valencia) ESPAÑA

Teléfono: +34 96 282 06 99

E-mail: [info@artemader.com](mailto:info@artemader.com)

Web: [www.artemader.com](http://www.artemader.com)



GiveMeFive!  
muebles  
GRUPO **INTERMOBEL**  
artemader